

CRACK FOKKER

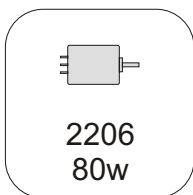

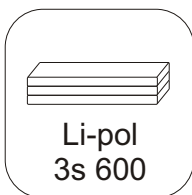

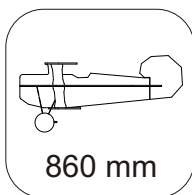

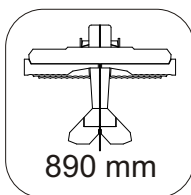
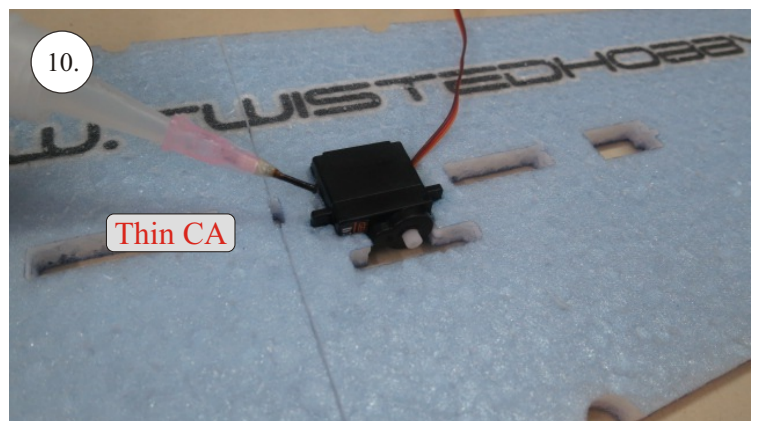
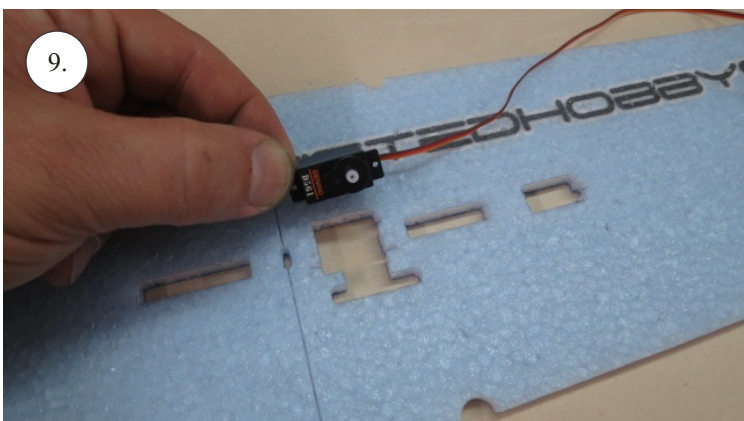
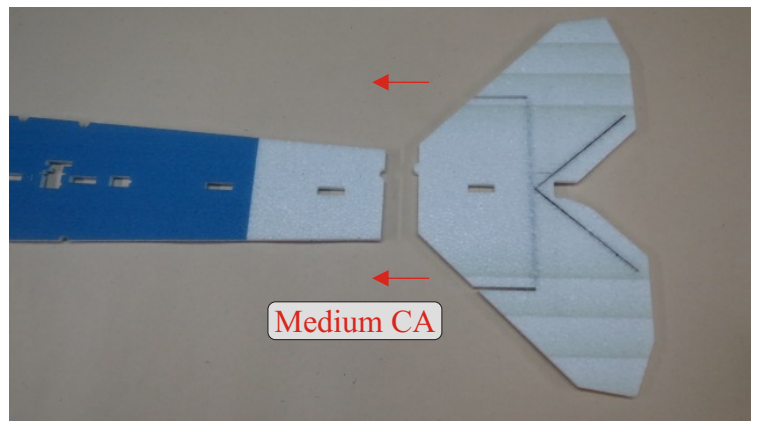
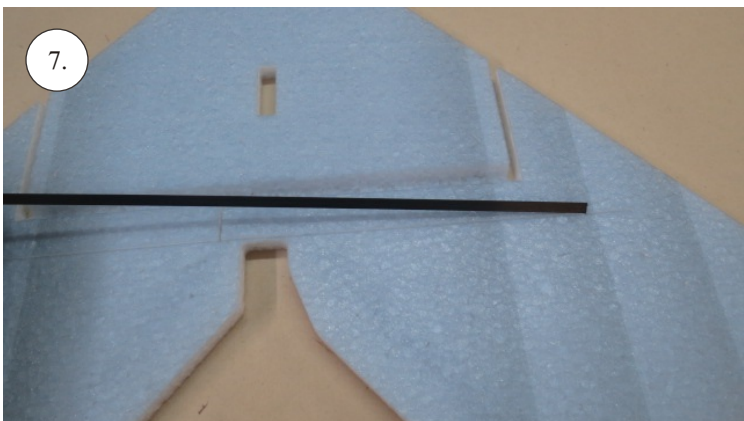
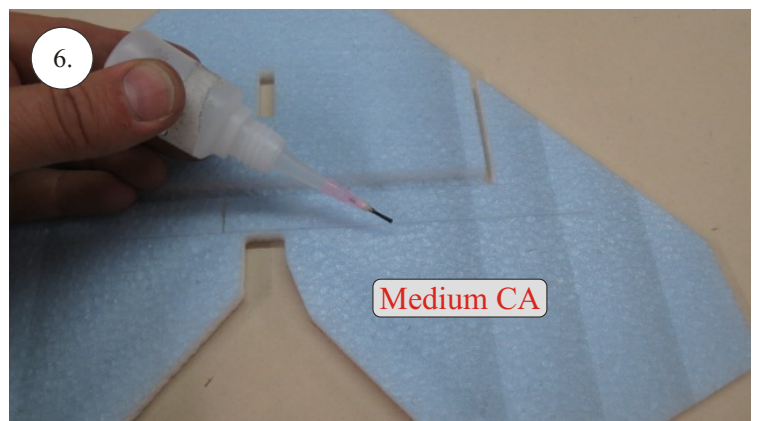
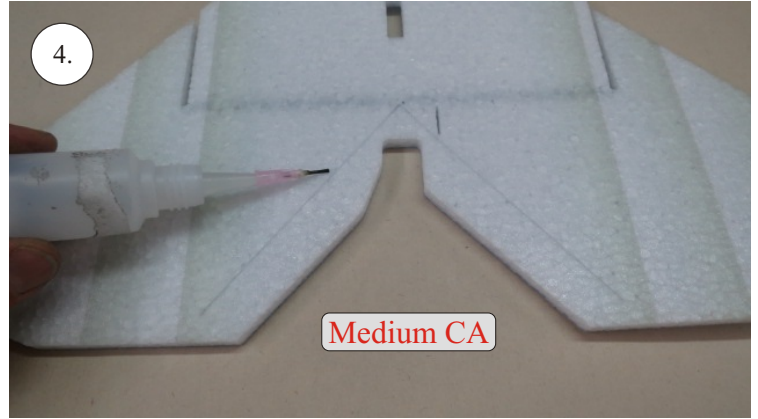
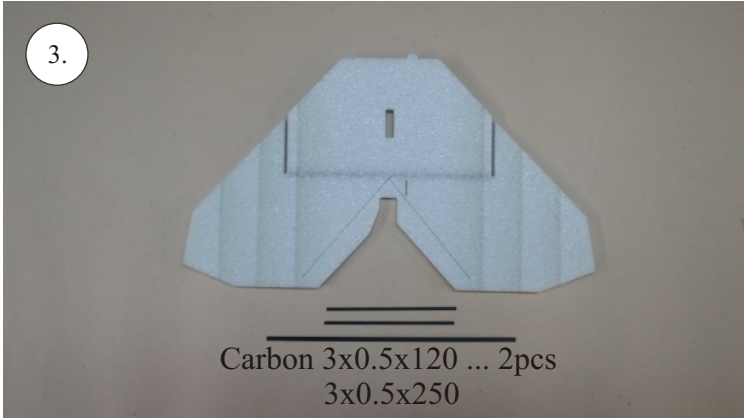
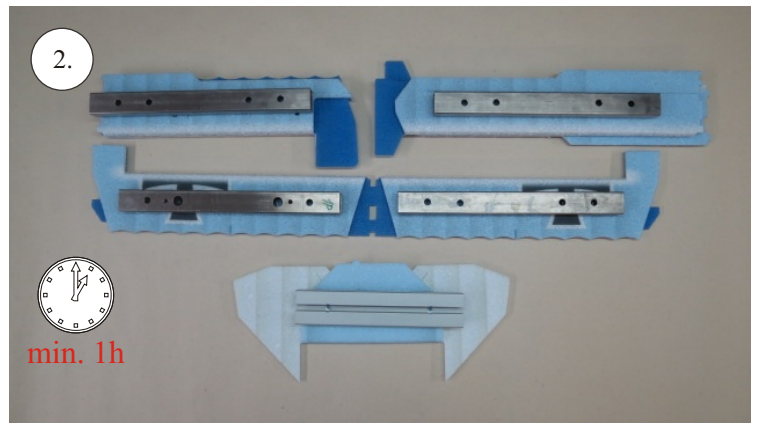
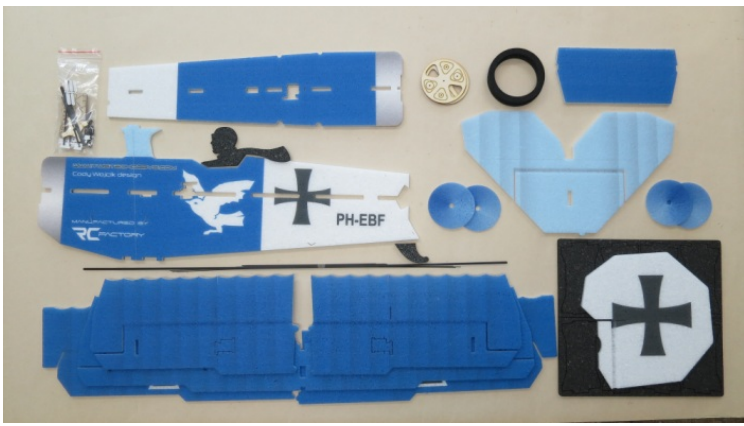
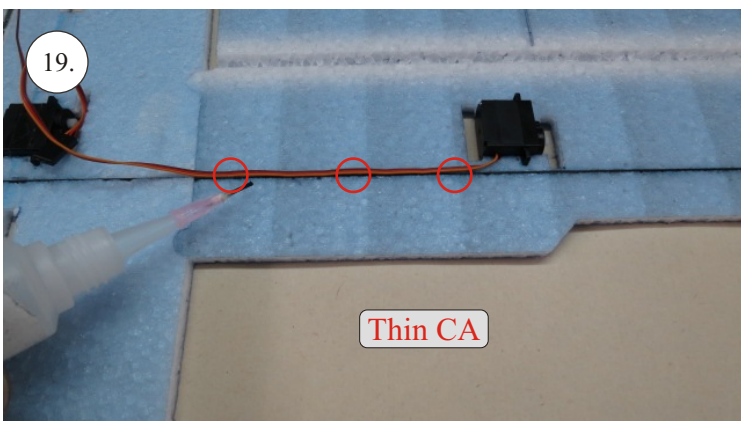
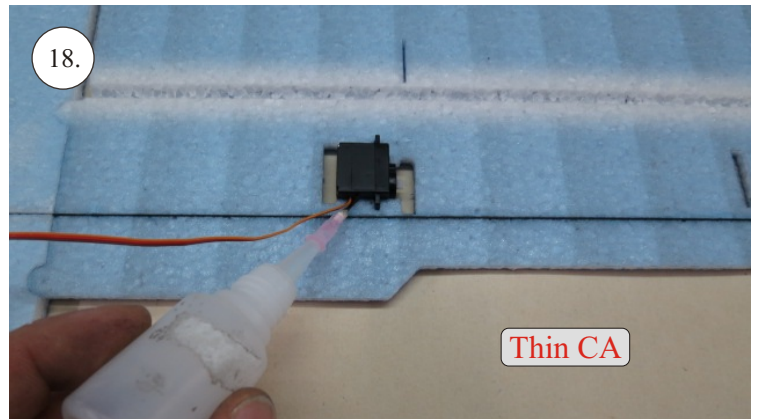
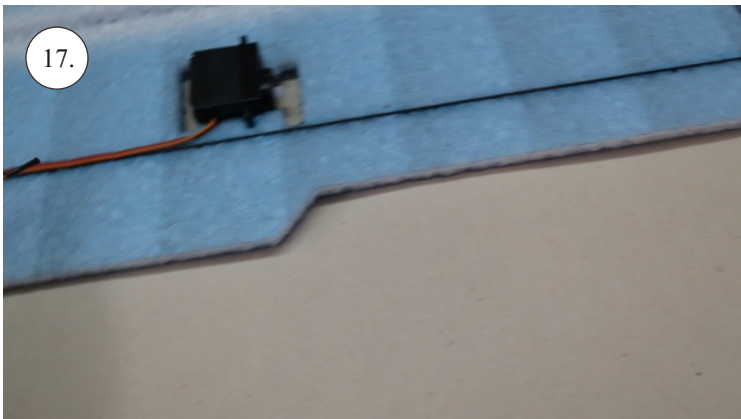
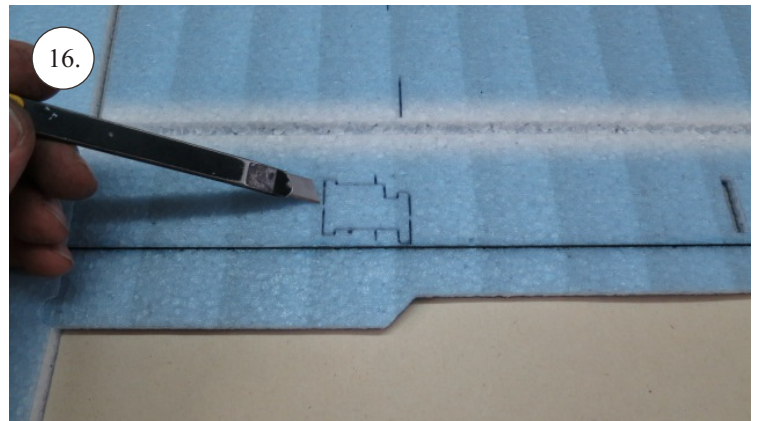
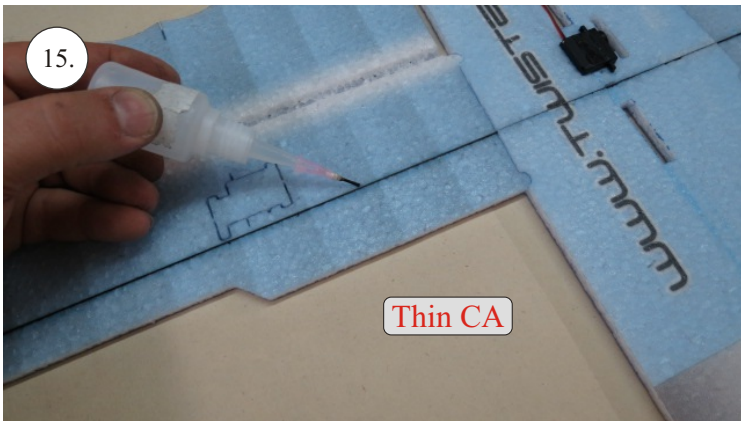
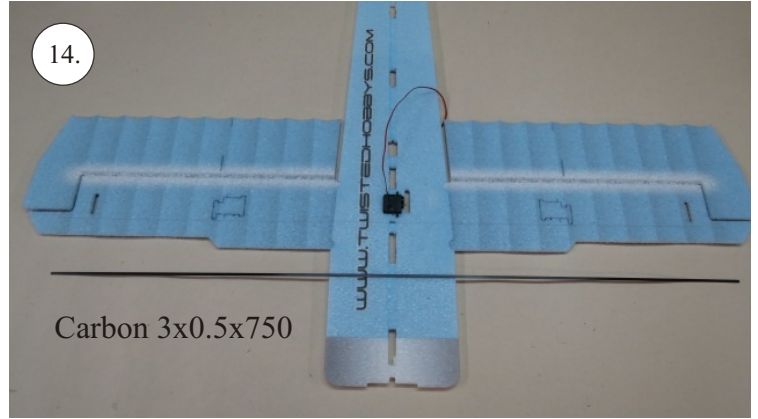
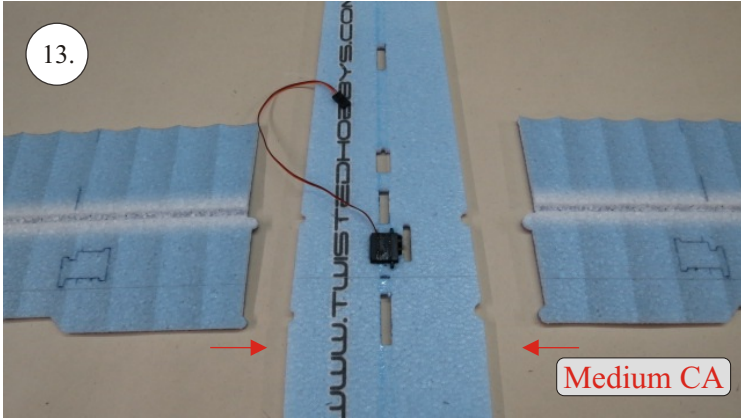
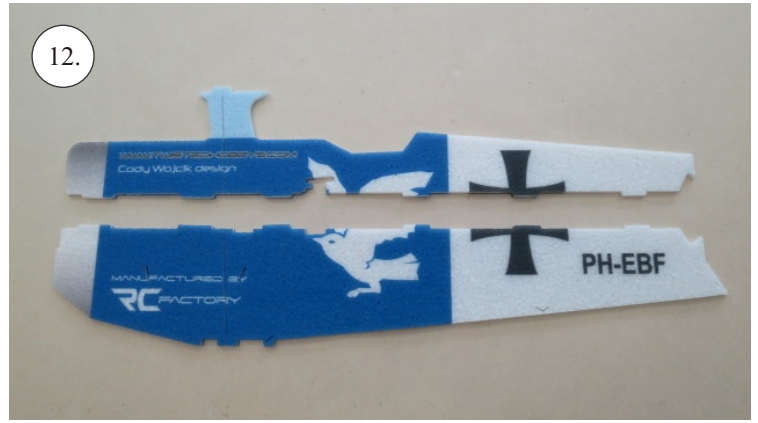
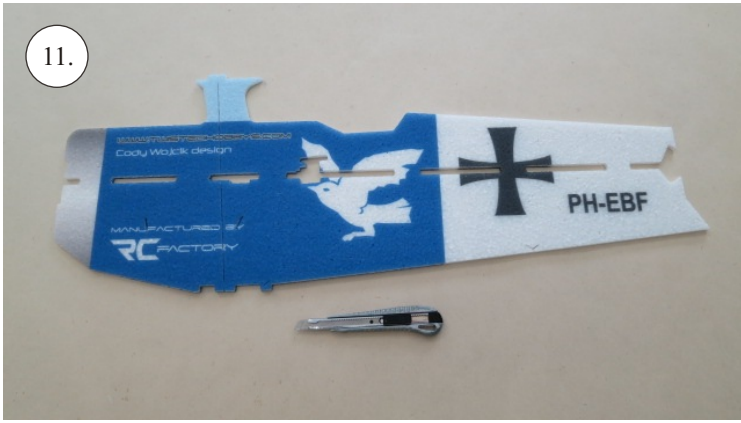
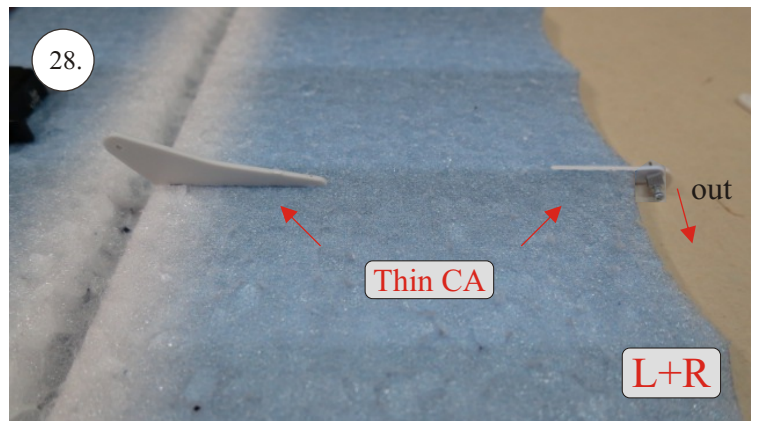
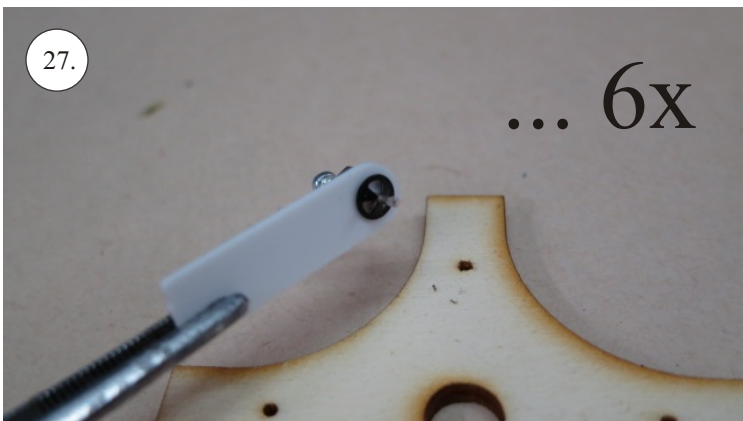
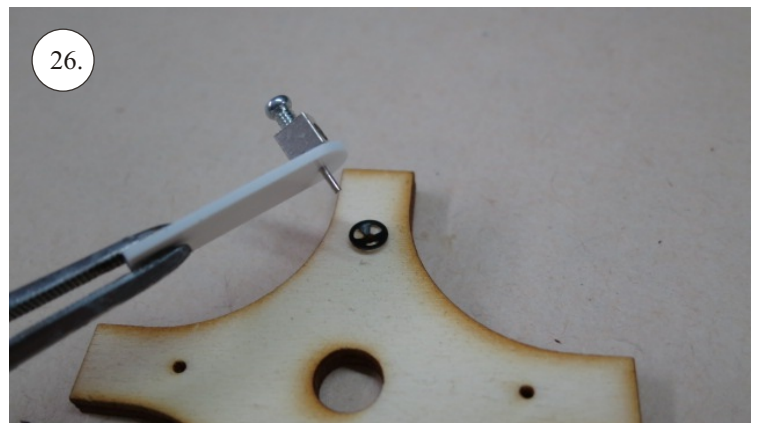
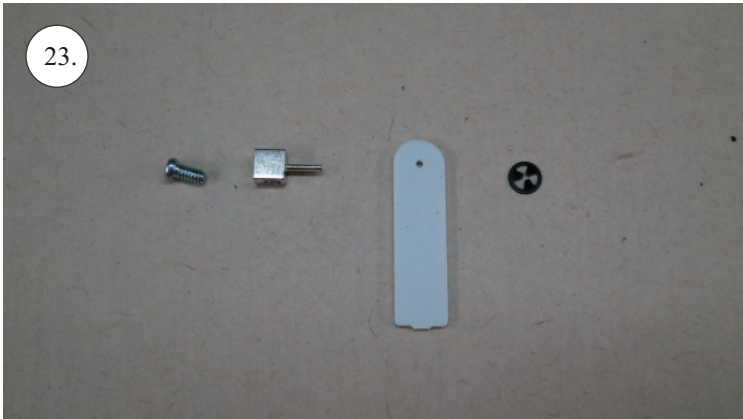
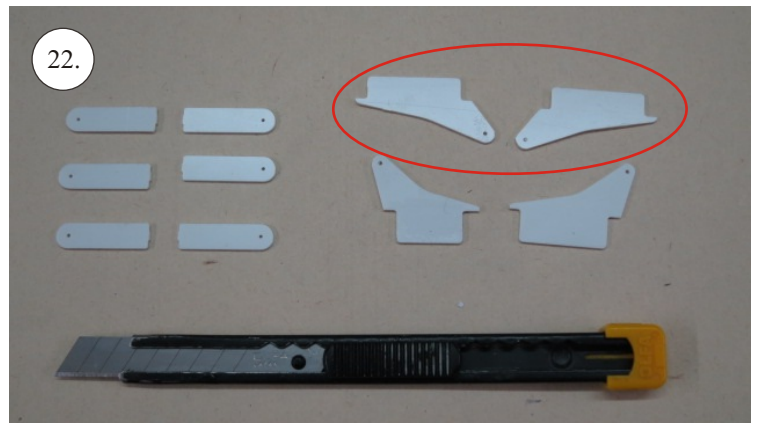
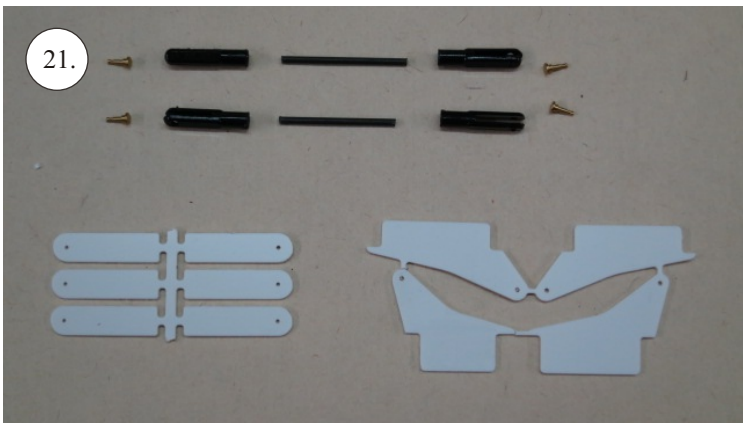

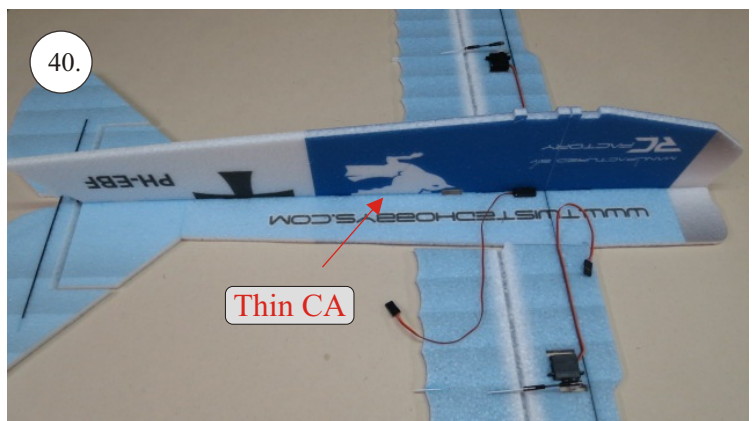
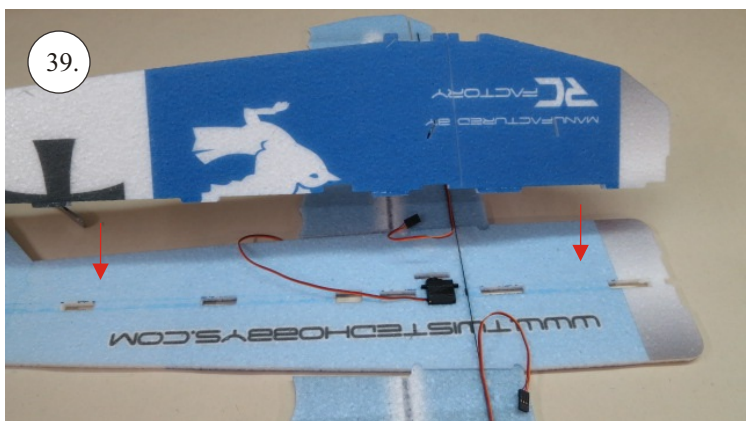
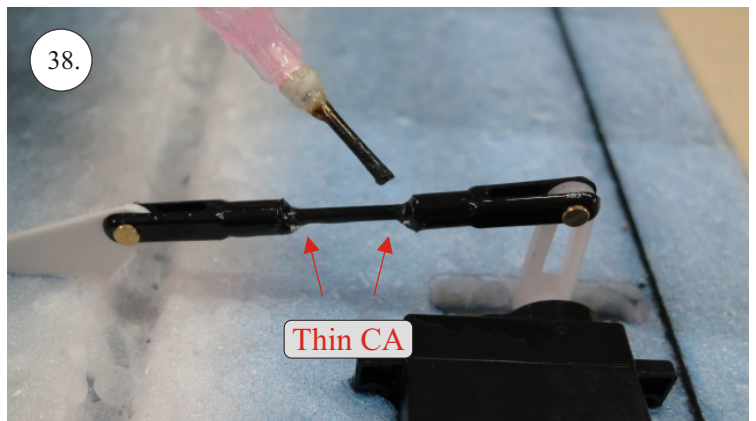
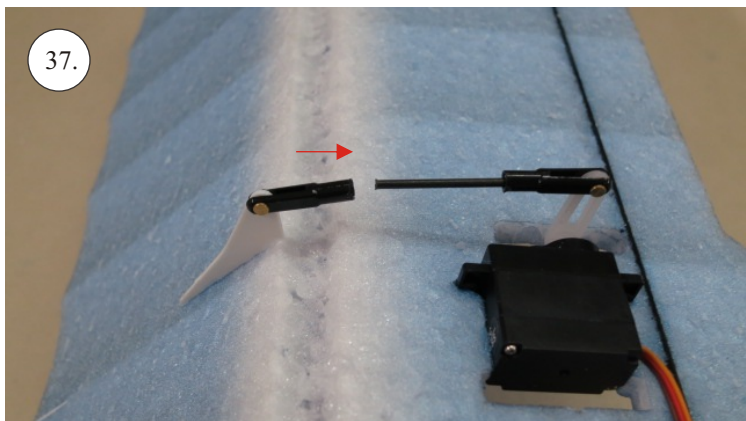
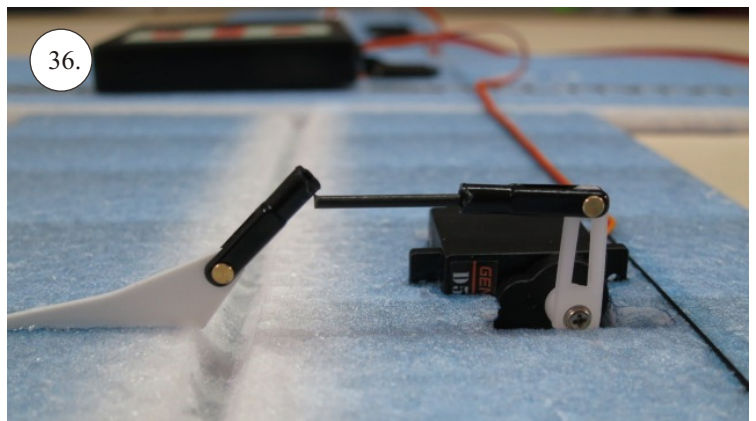
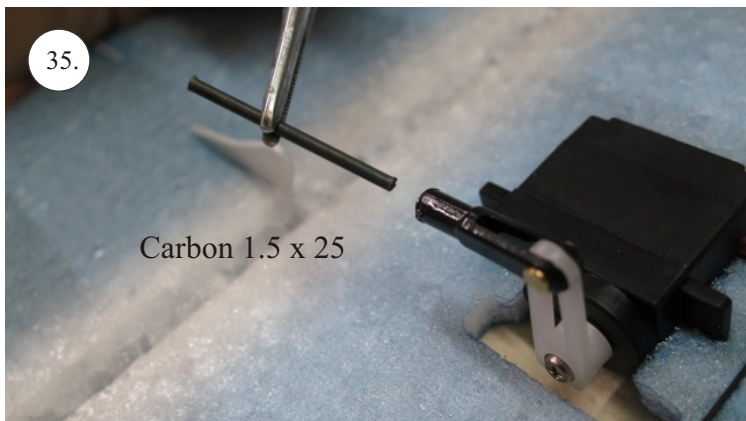
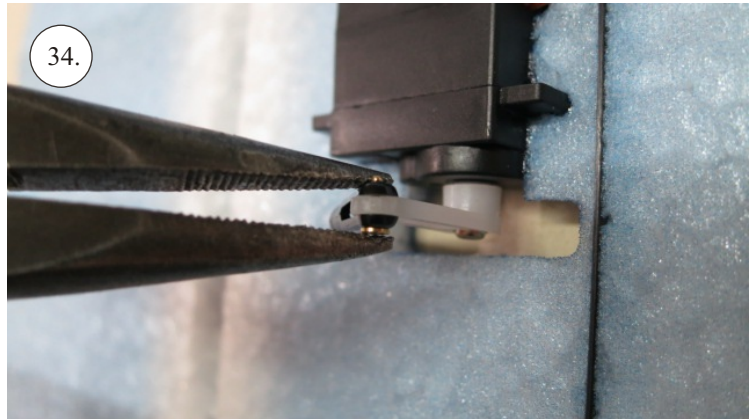
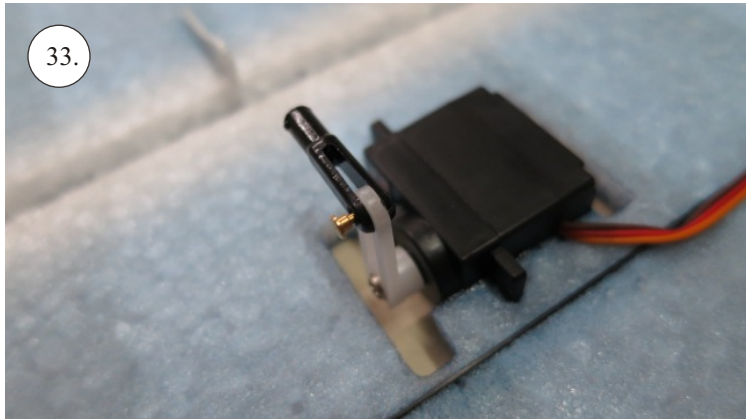
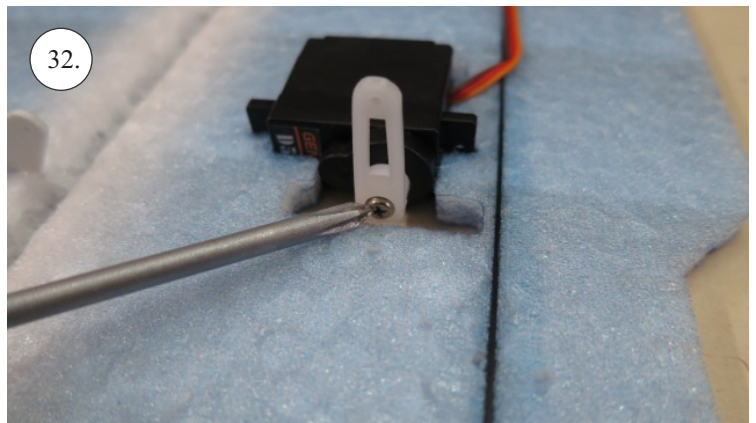
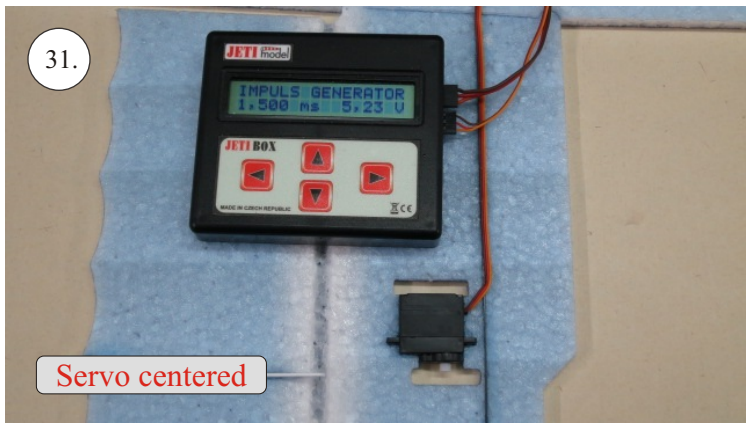

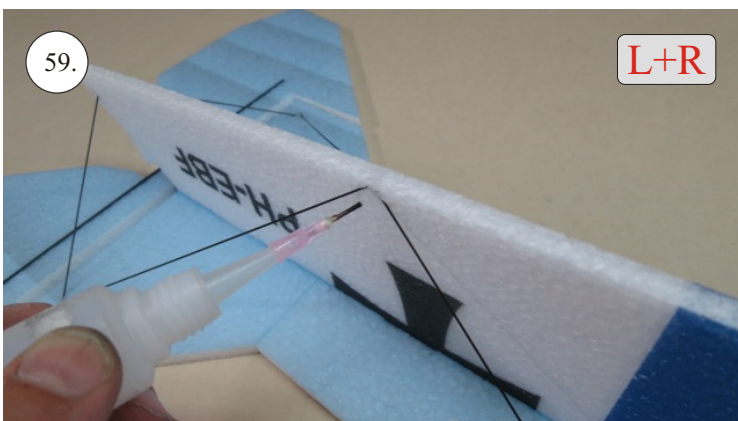
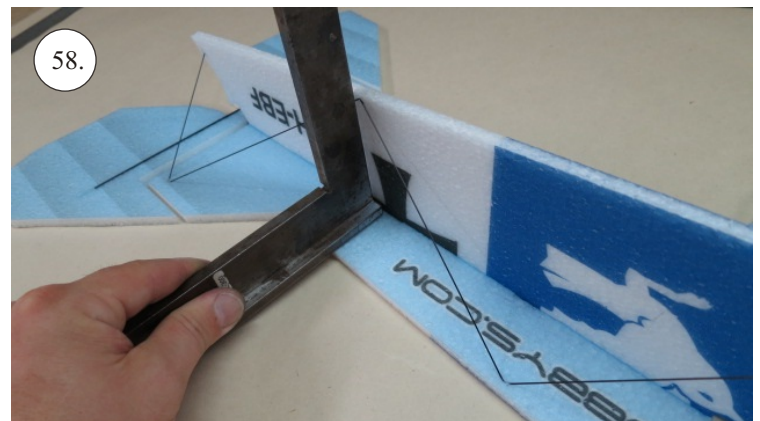
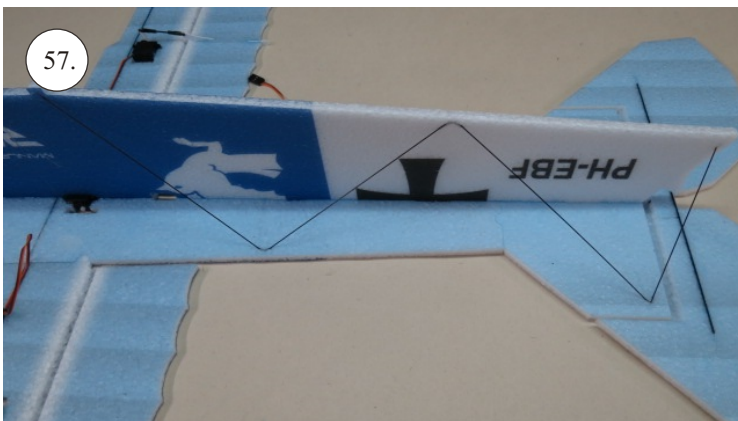
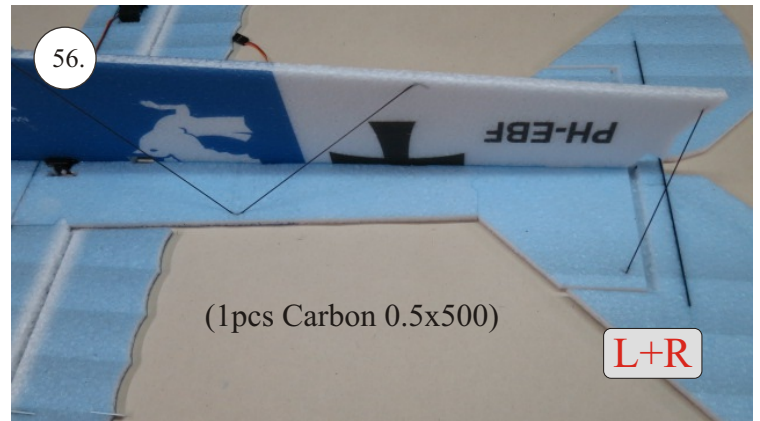
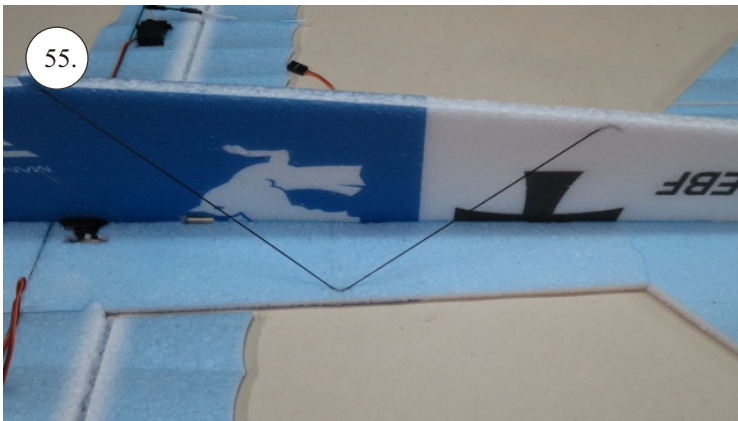
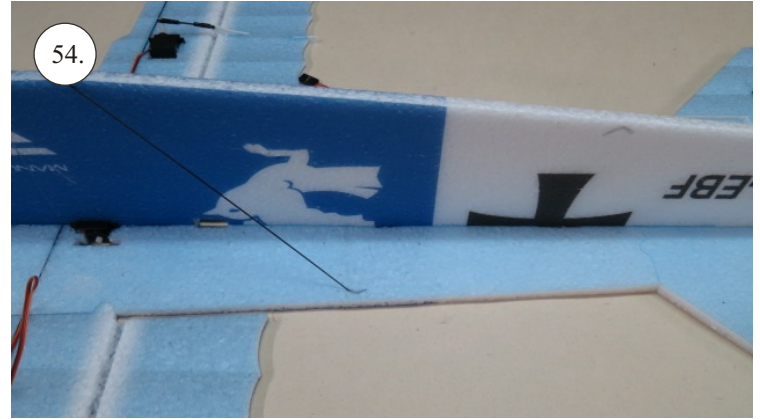
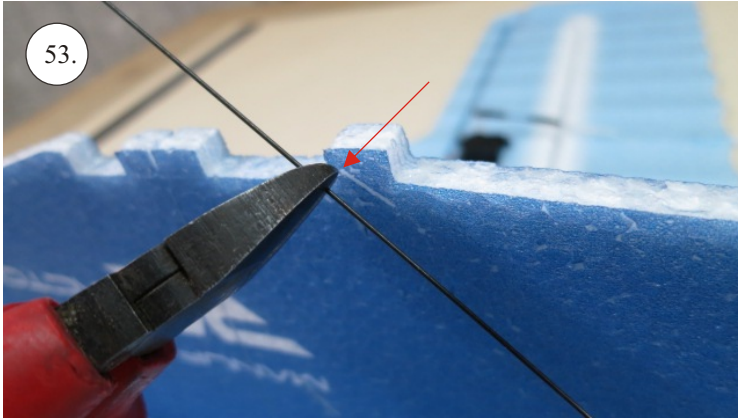
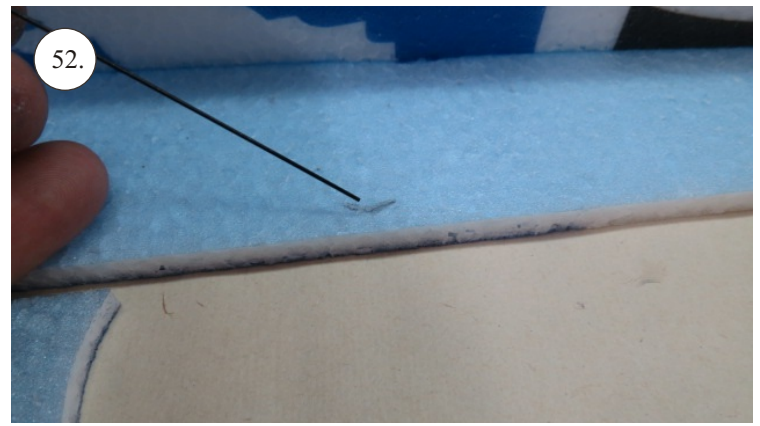
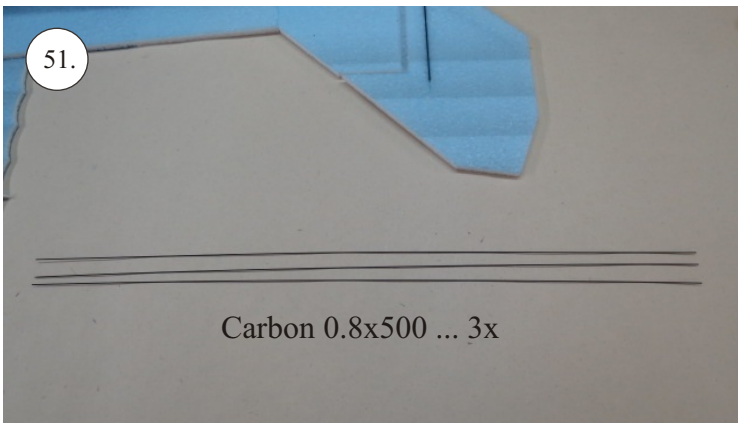

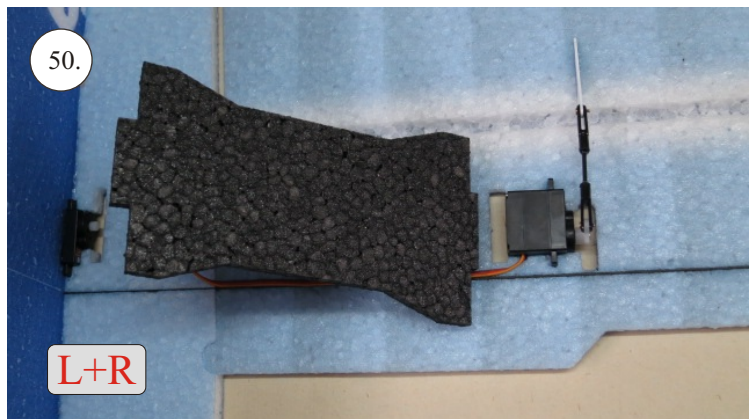
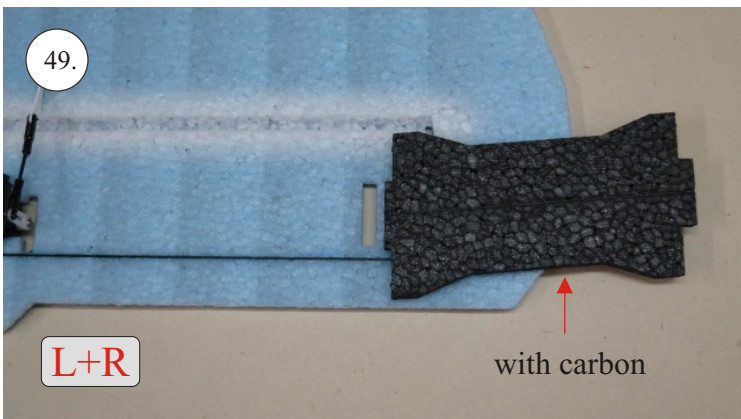
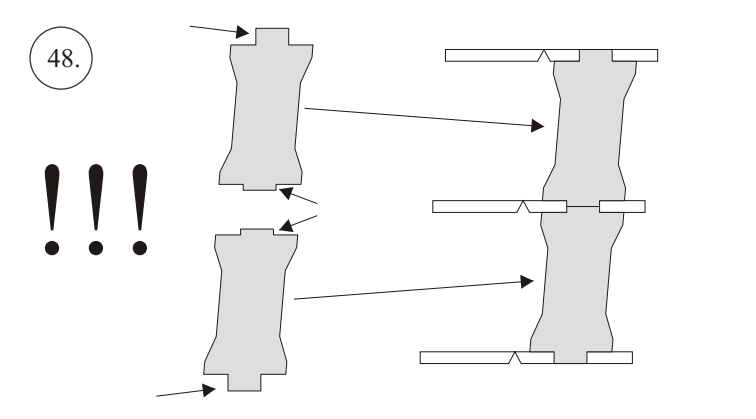
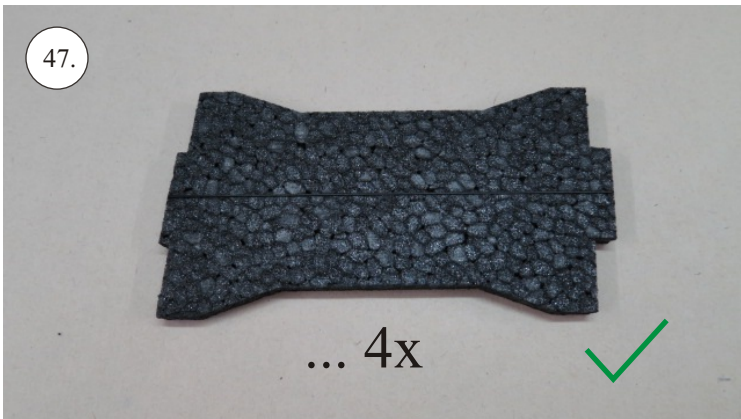
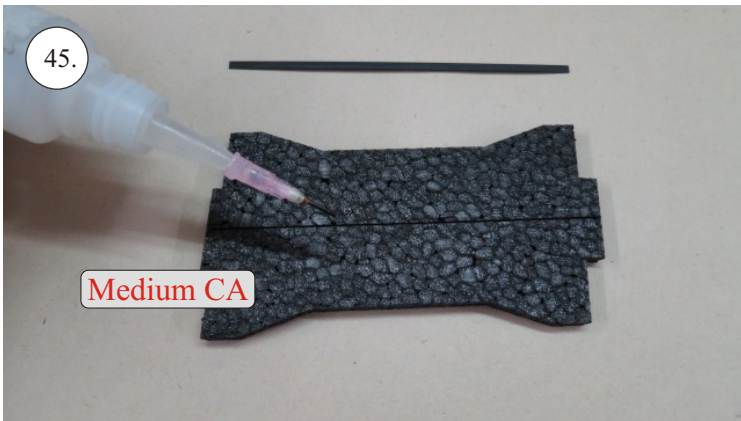
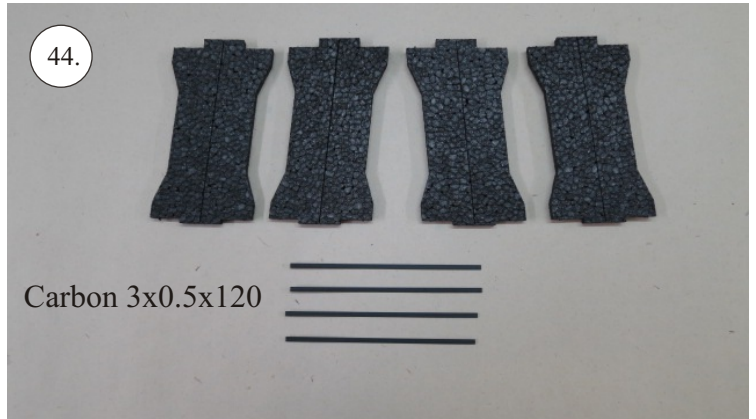
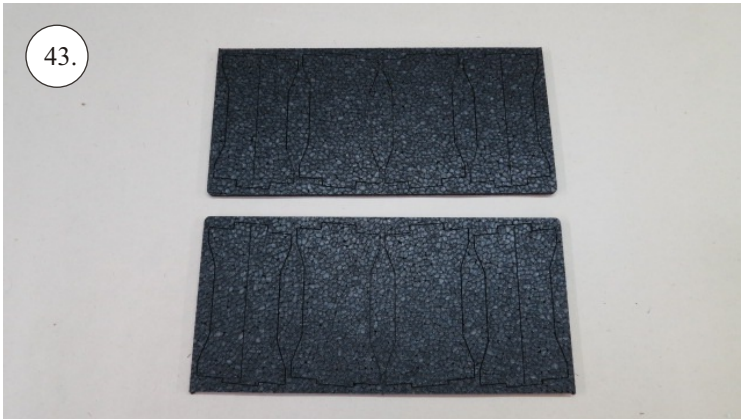
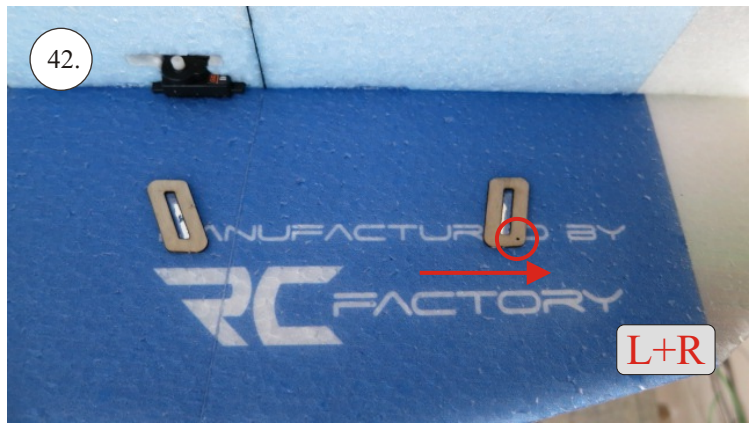
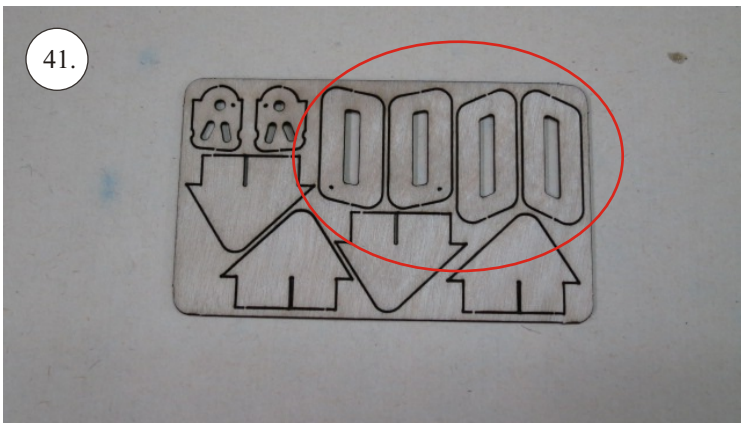

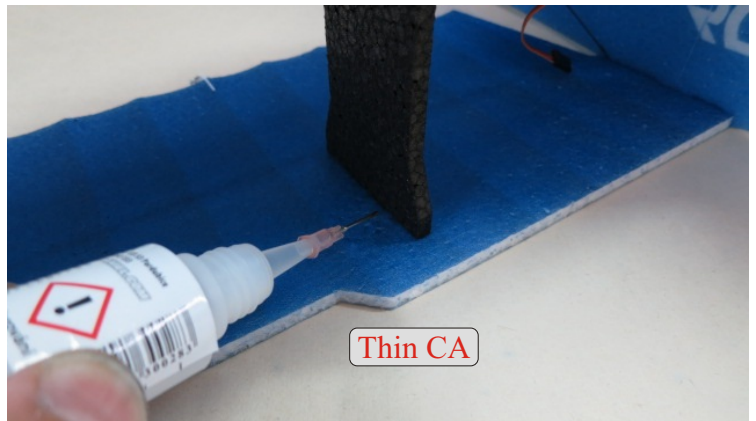
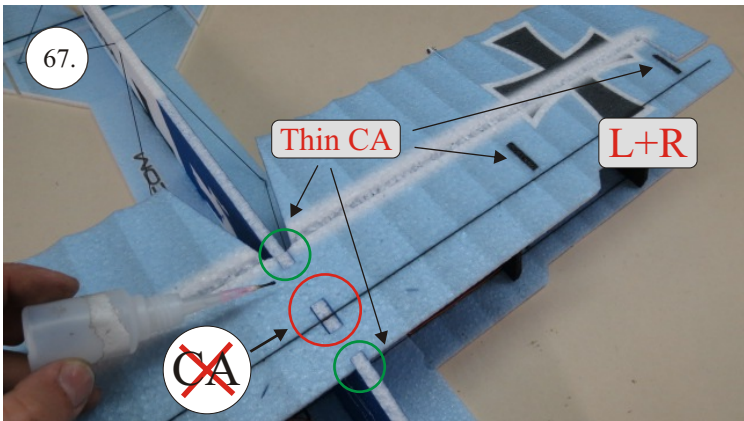
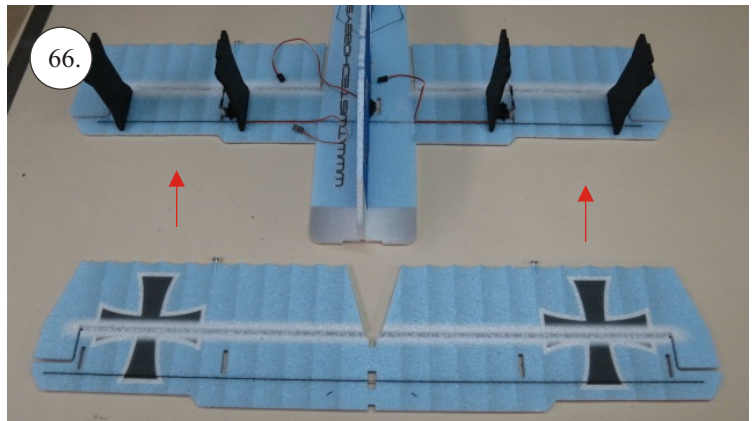
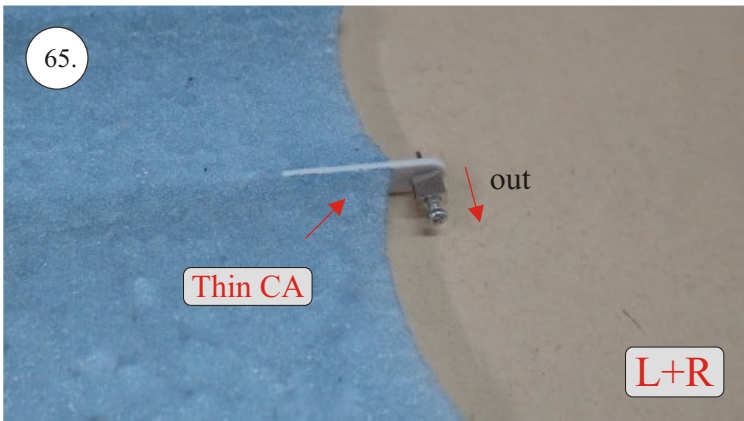
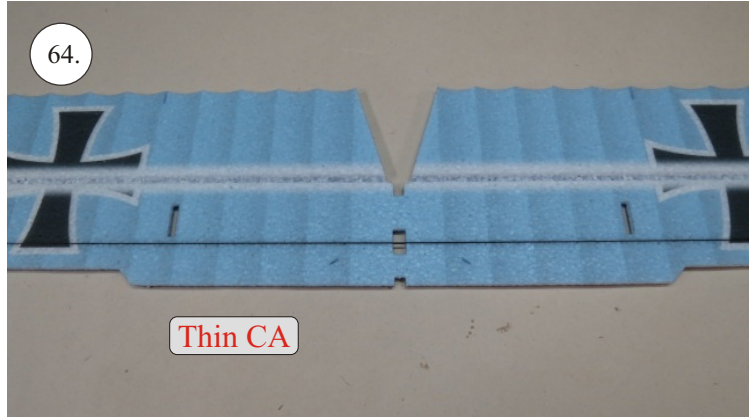
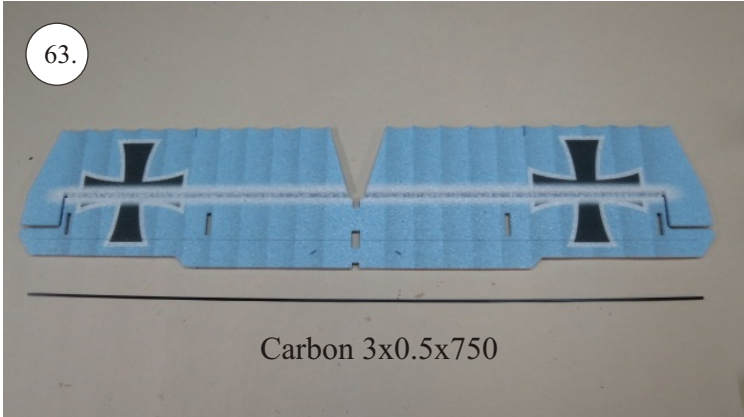
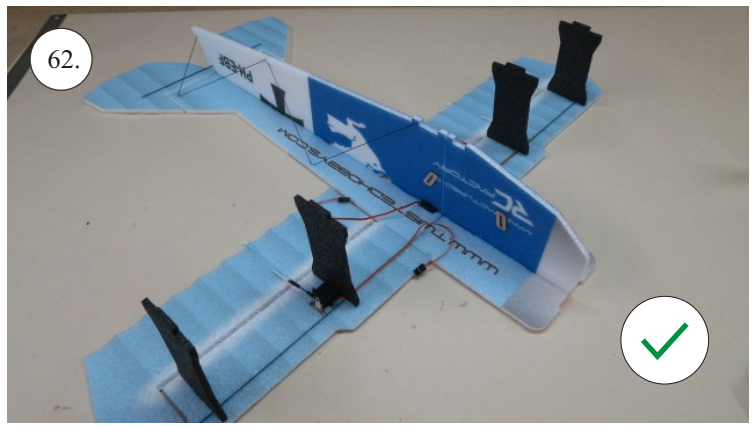
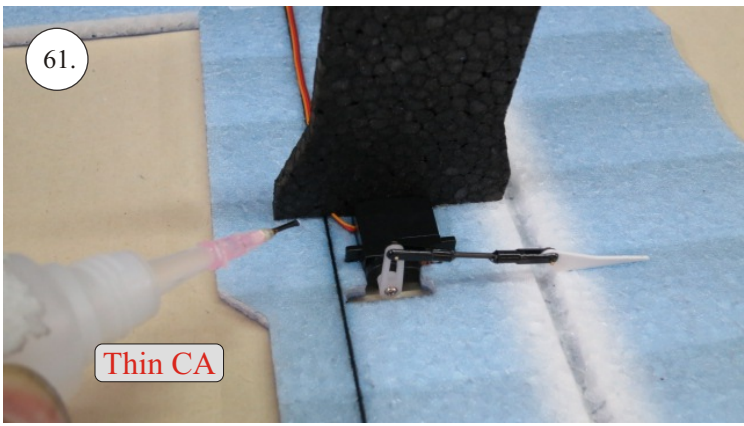

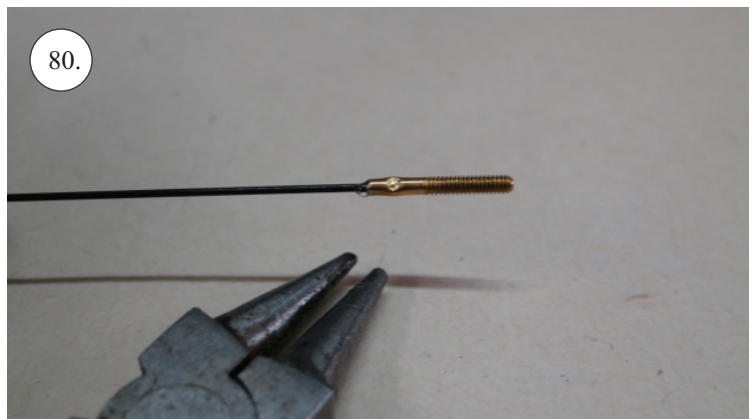
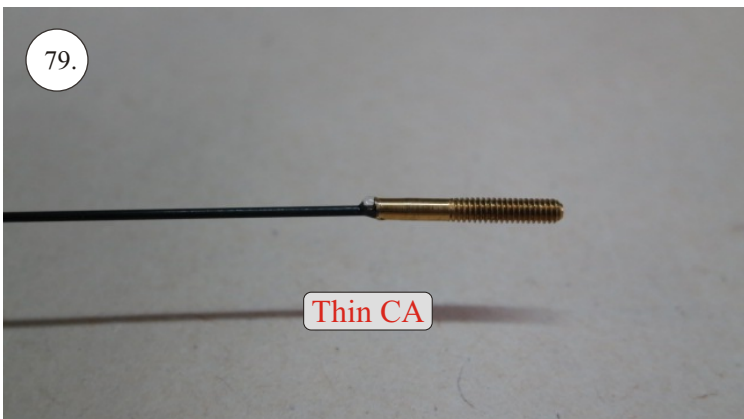
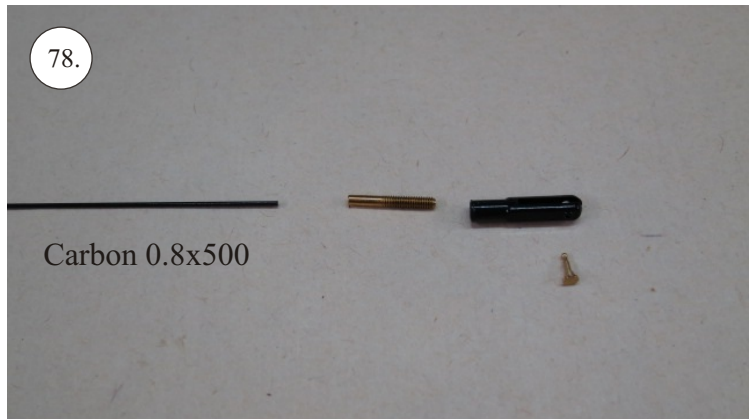
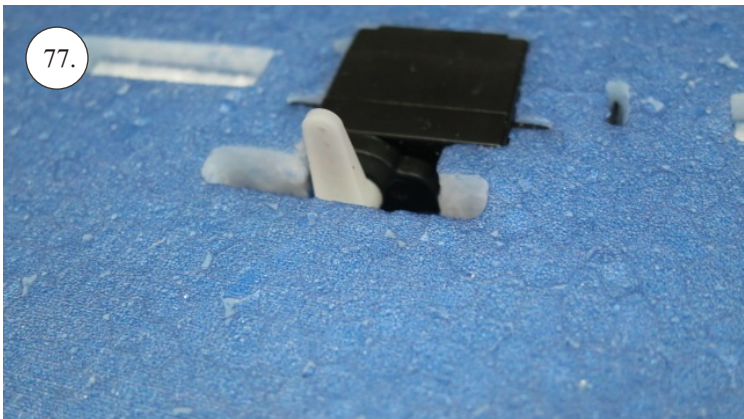
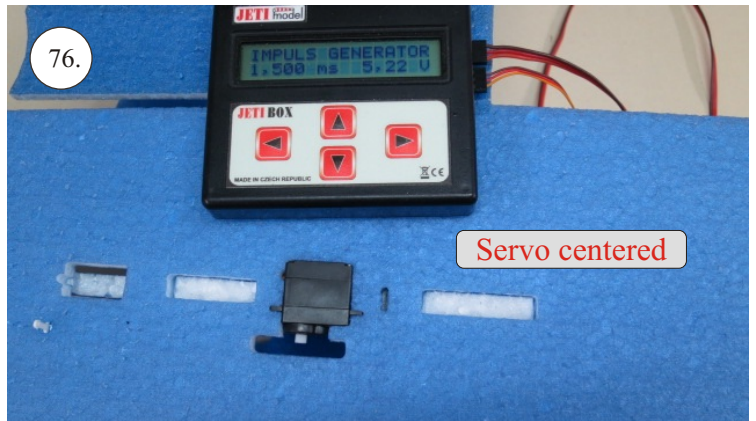
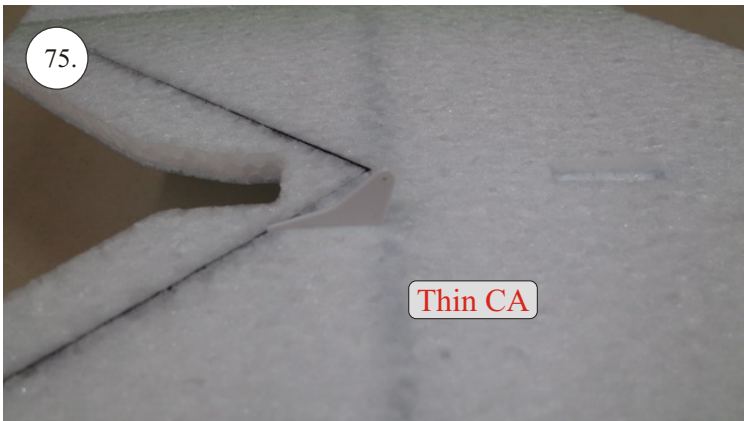
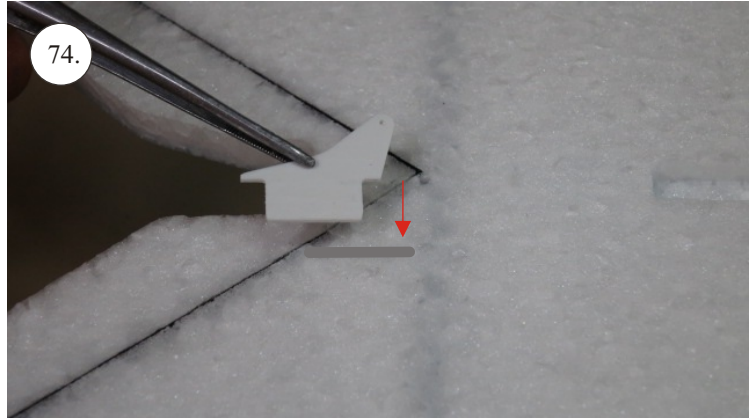
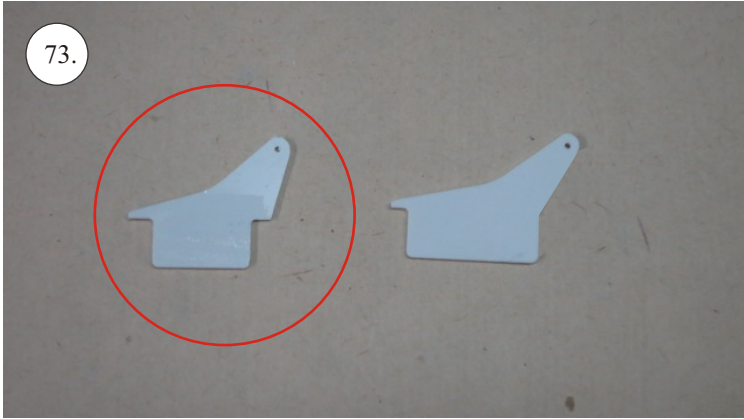
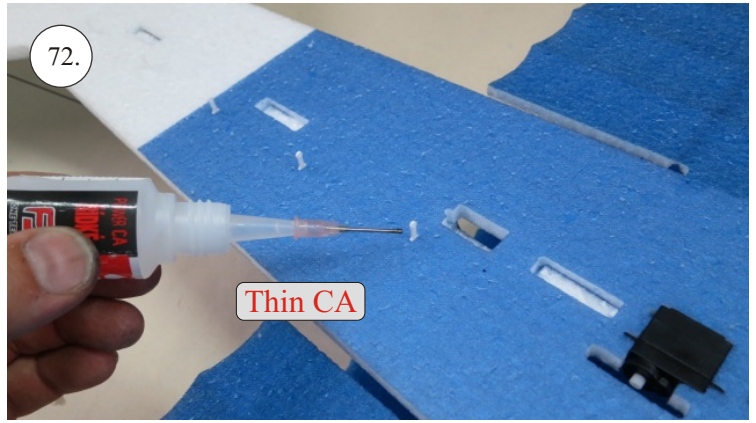
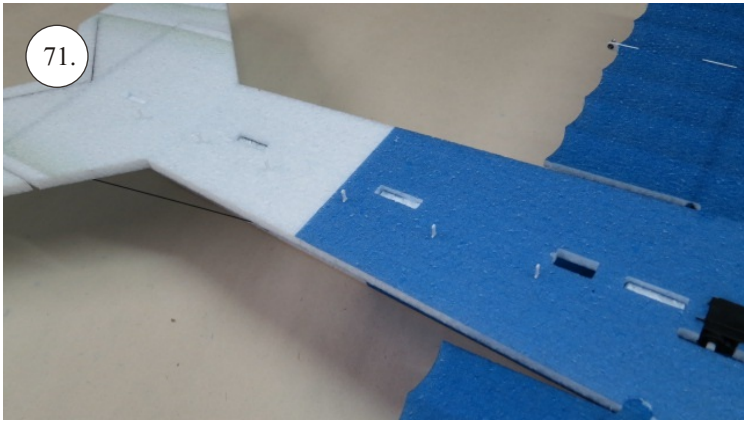

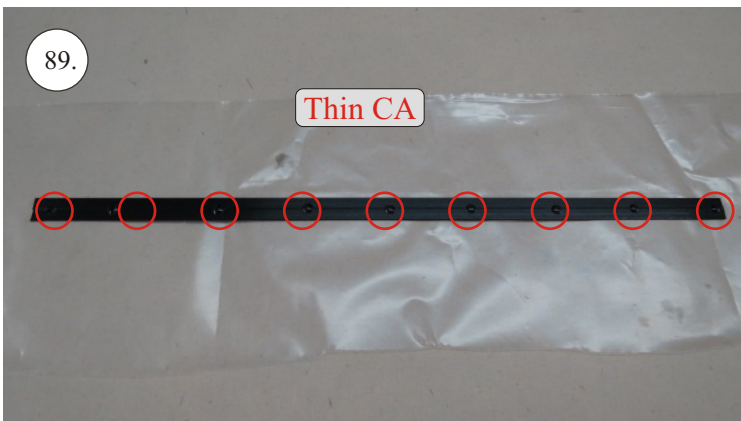
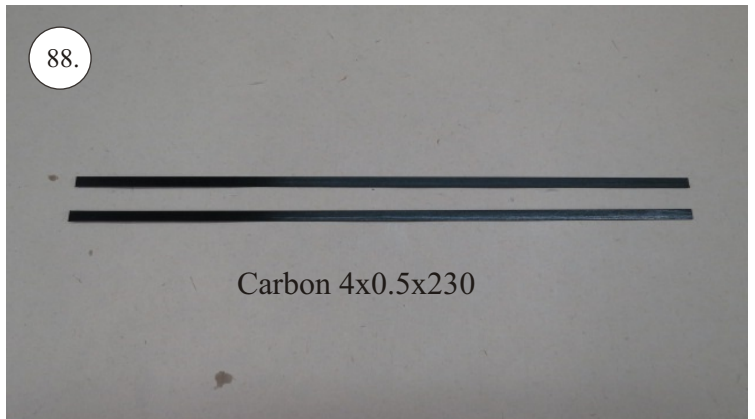
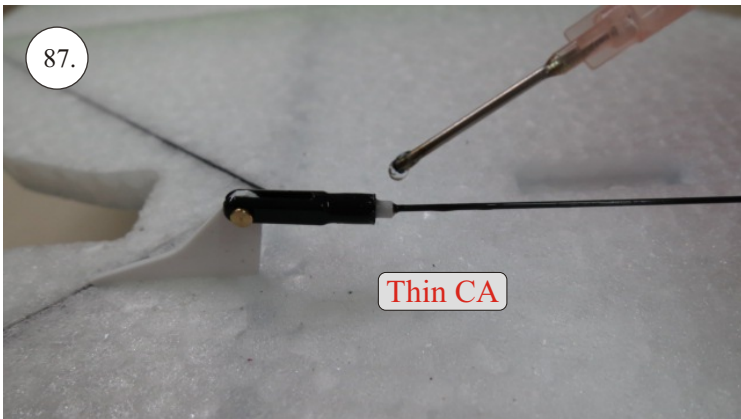
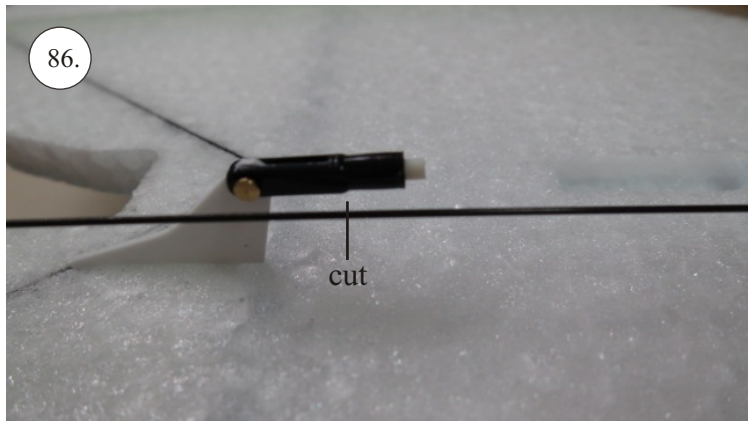
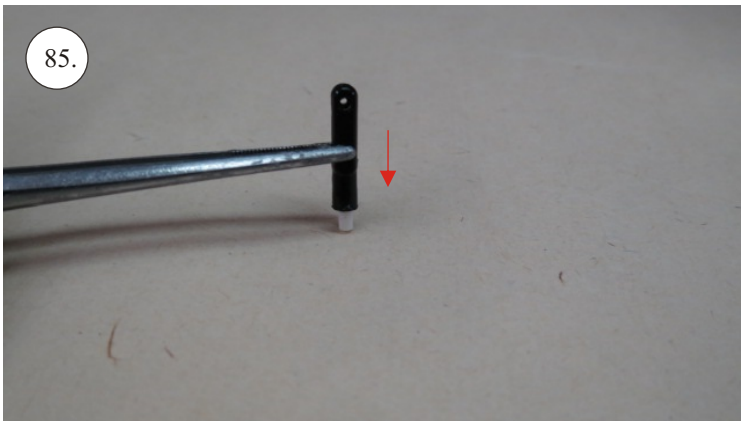
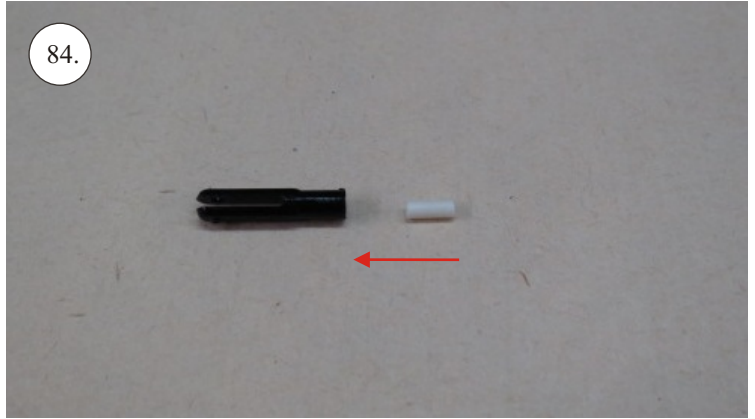
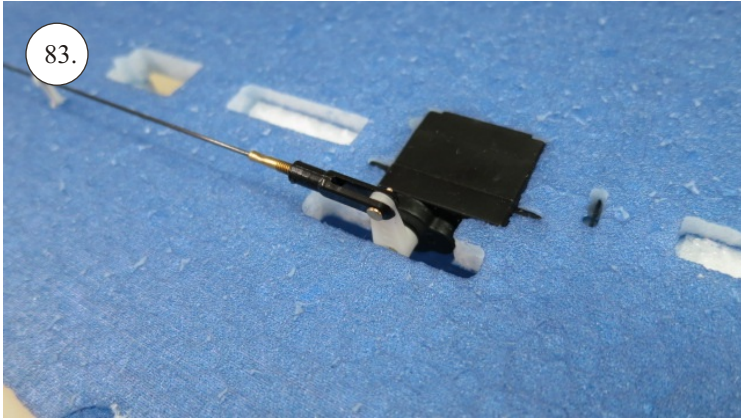
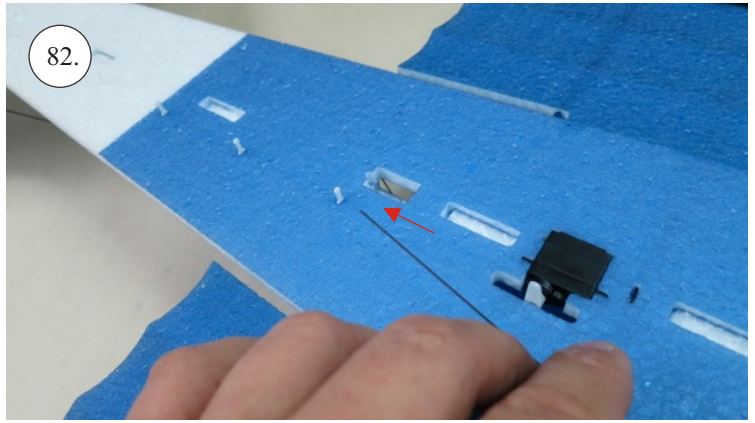

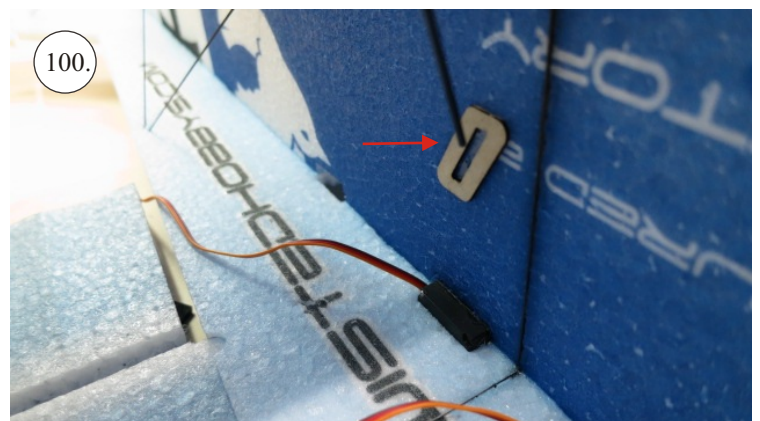
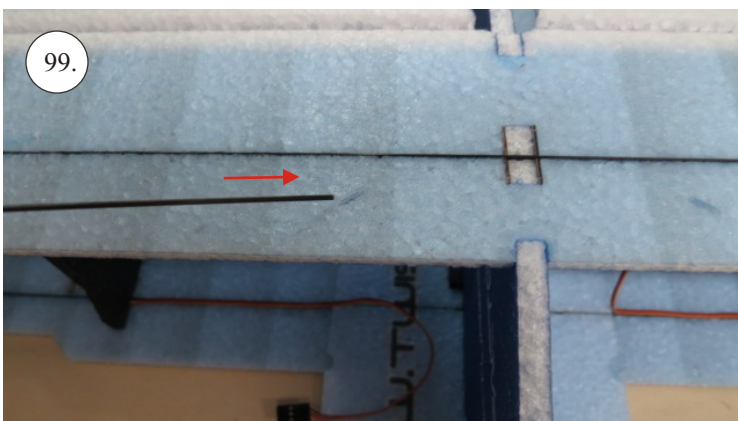
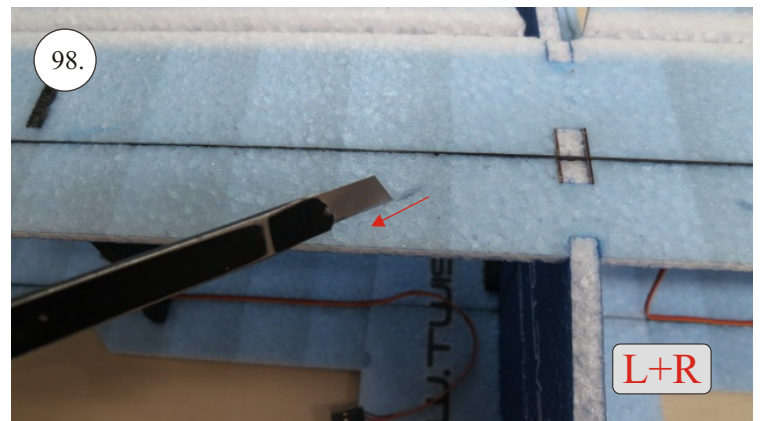
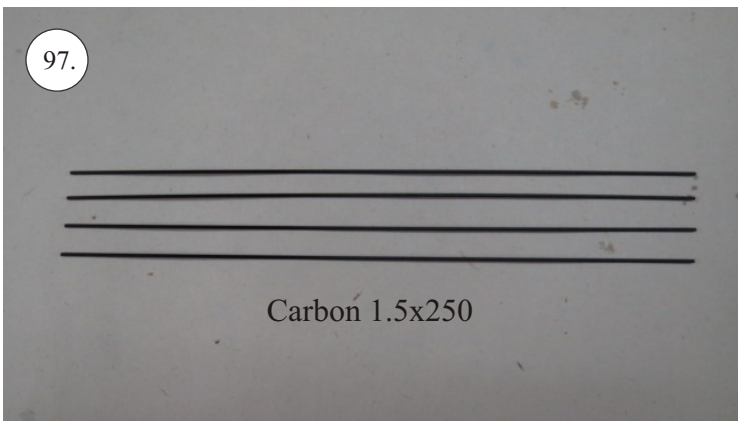
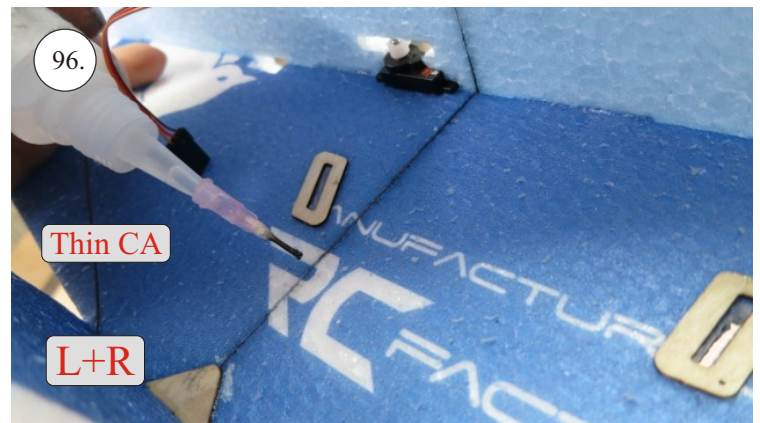
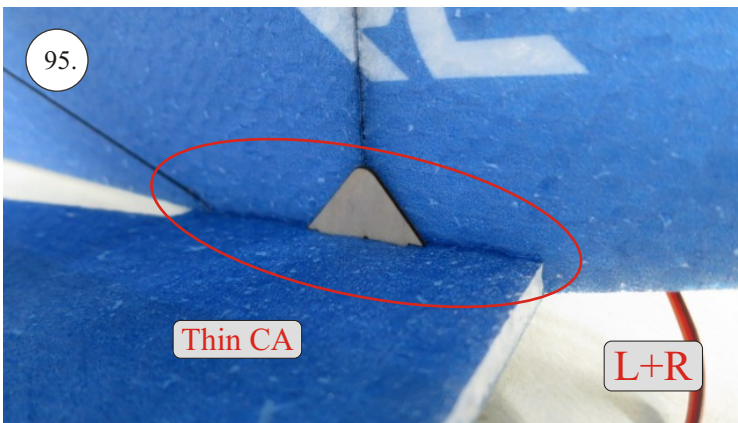
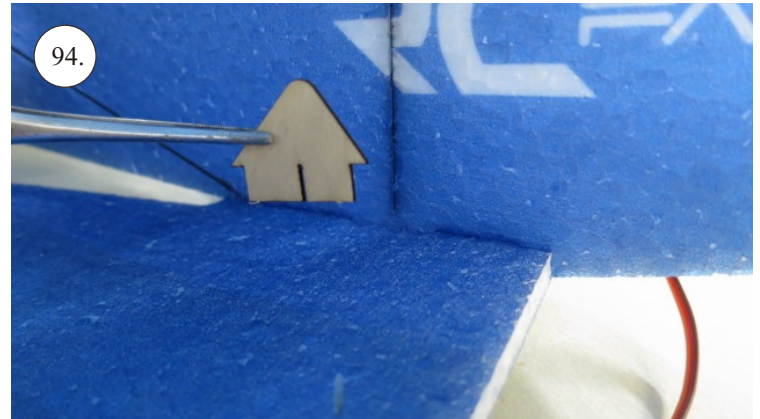
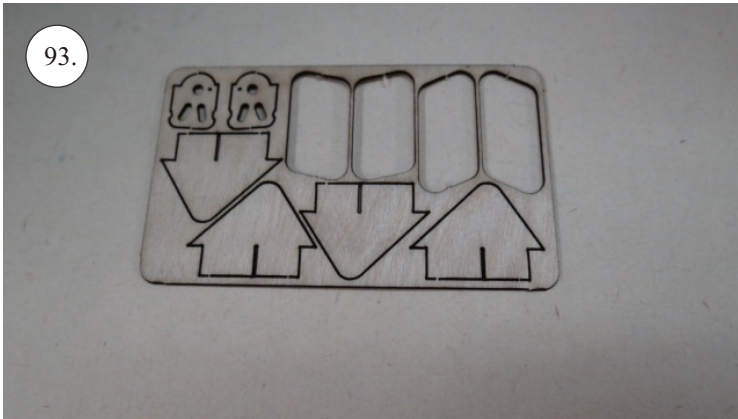
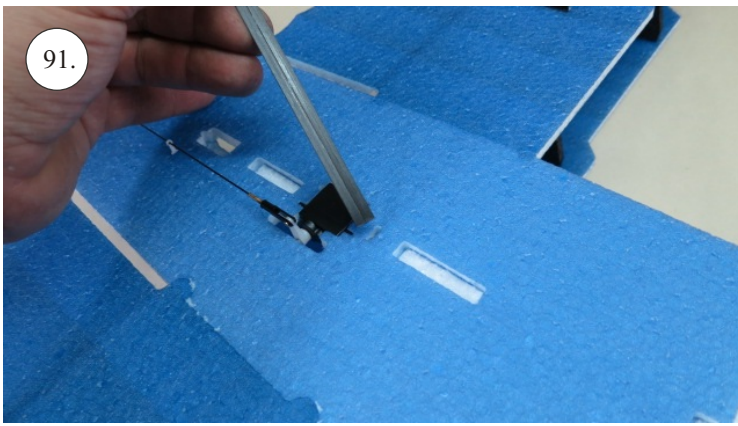

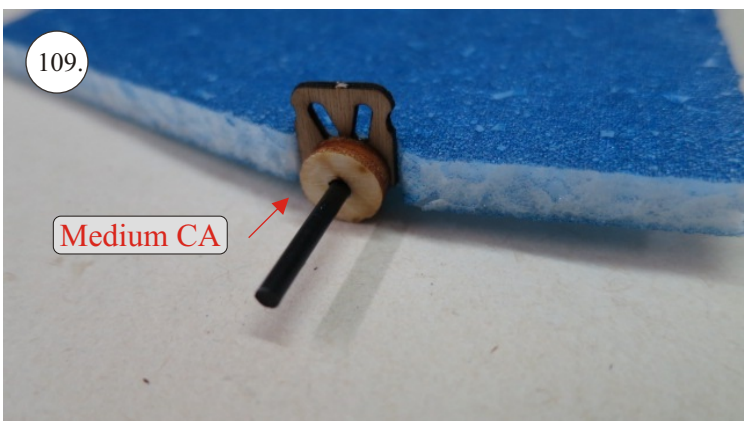
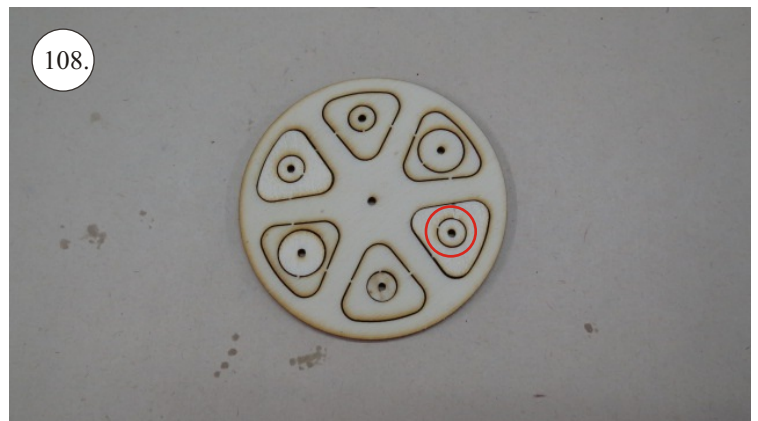
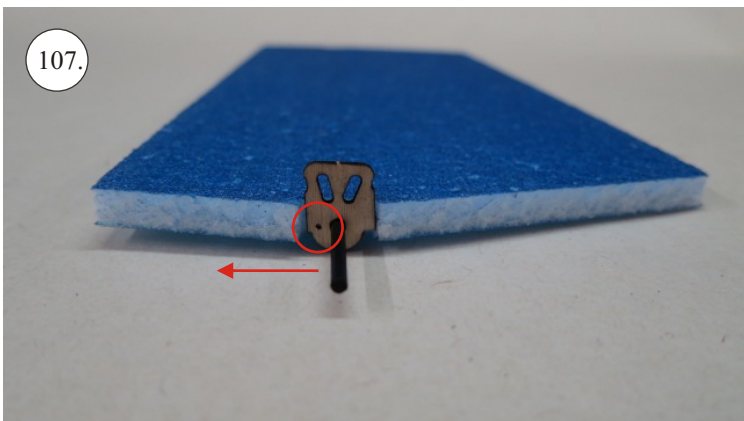
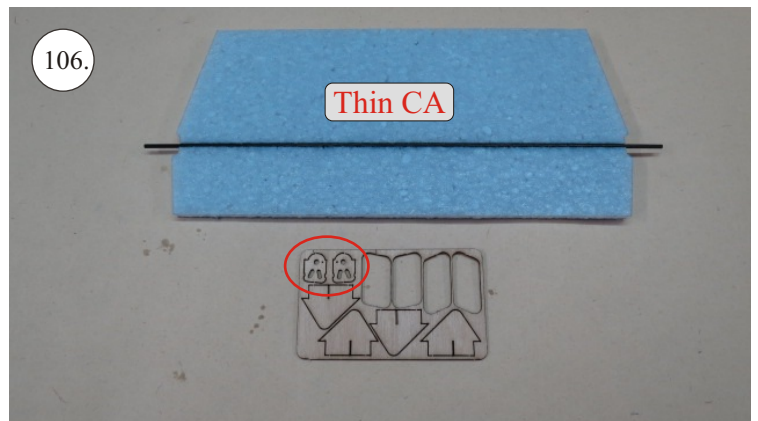
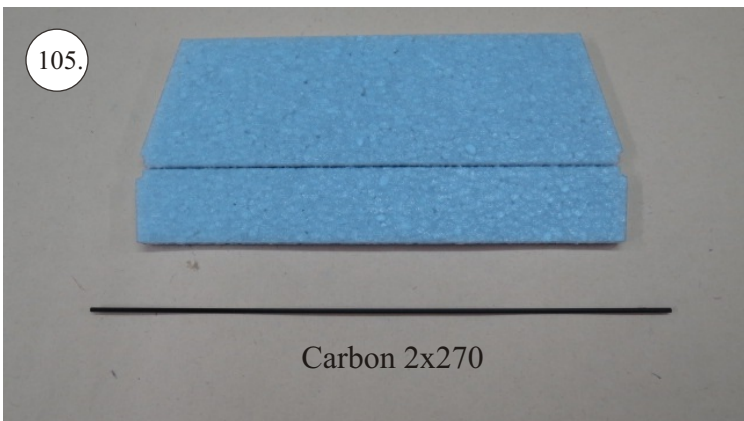
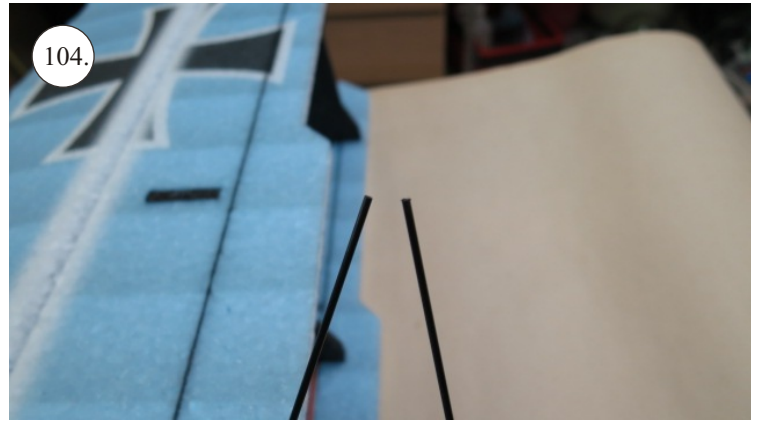
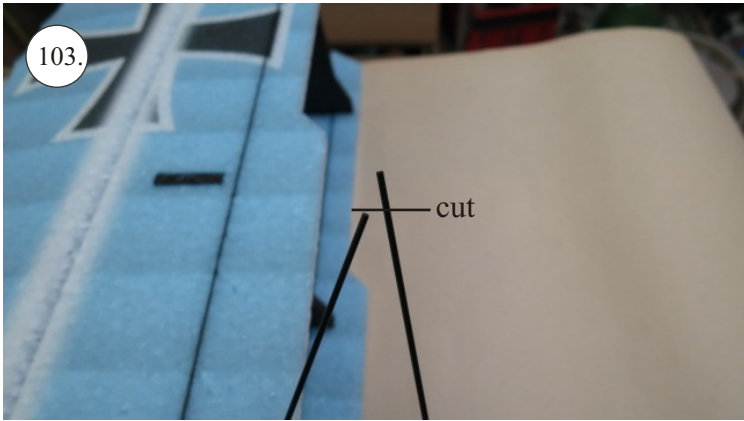
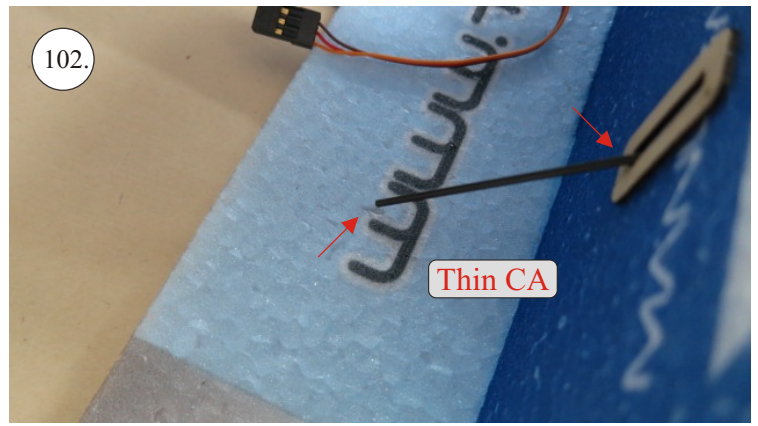
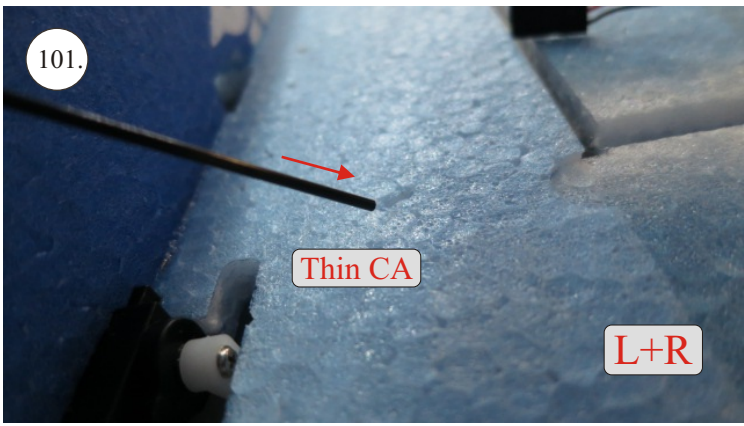

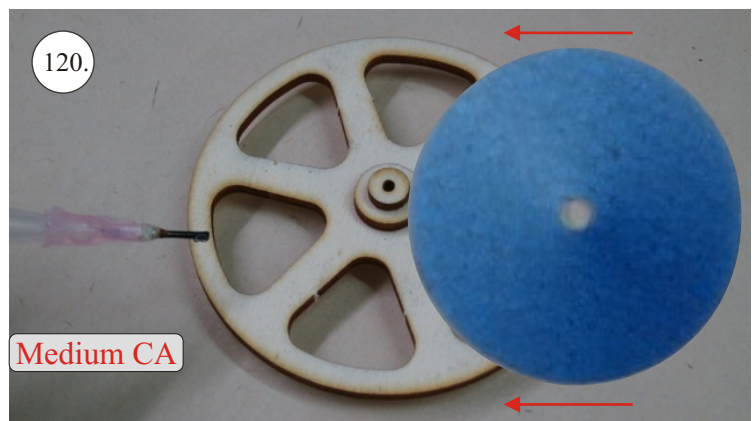
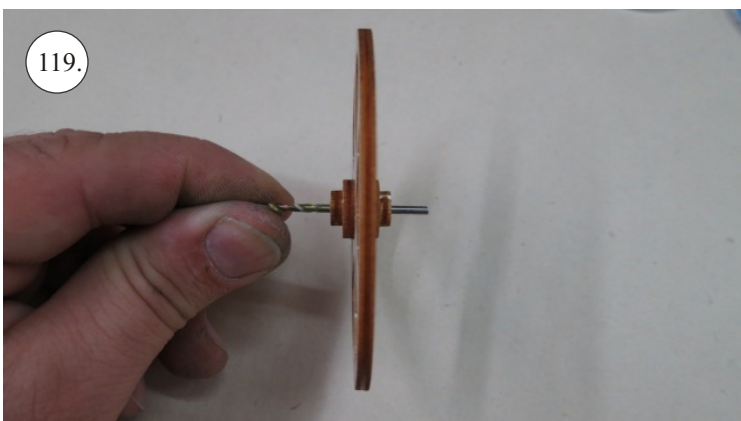
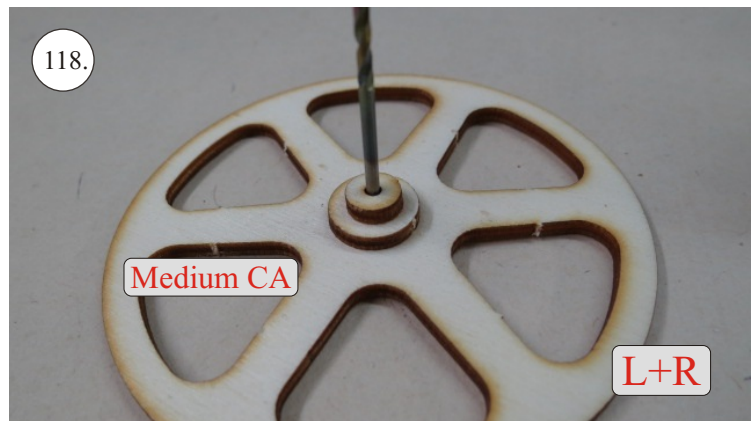
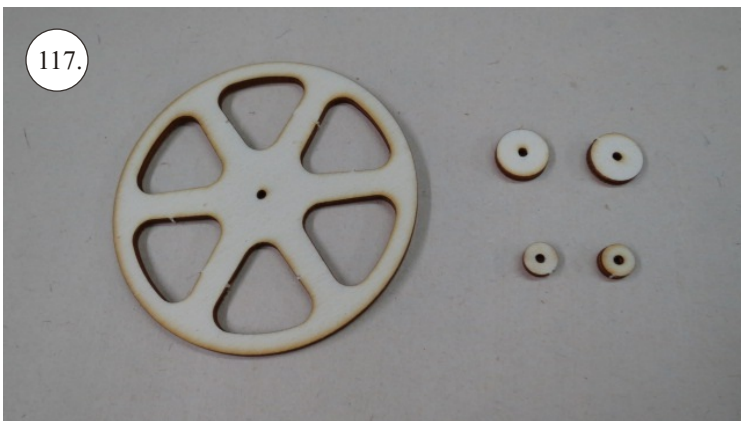
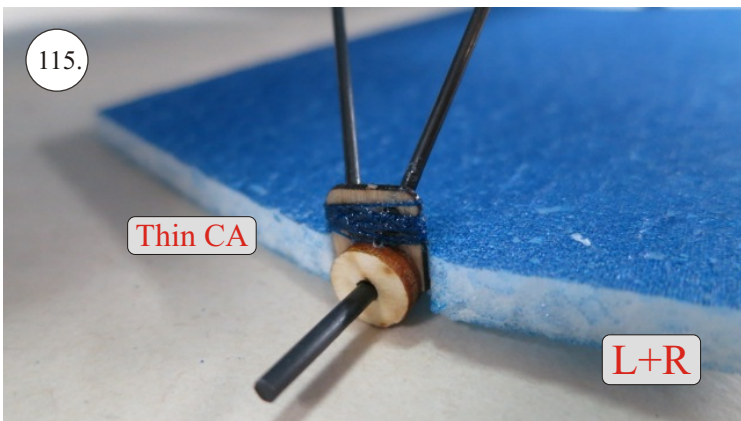
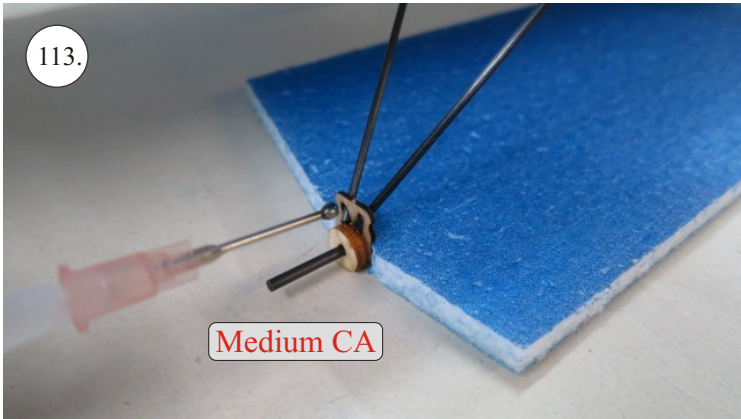
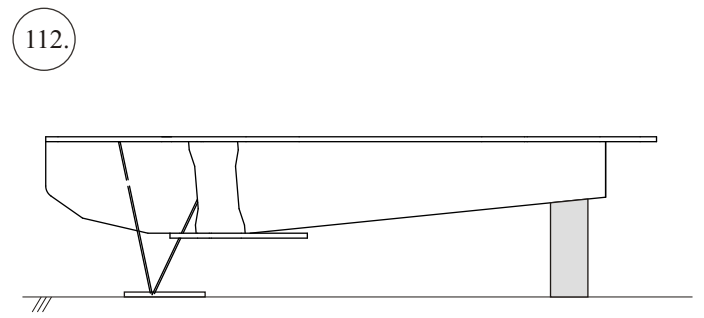
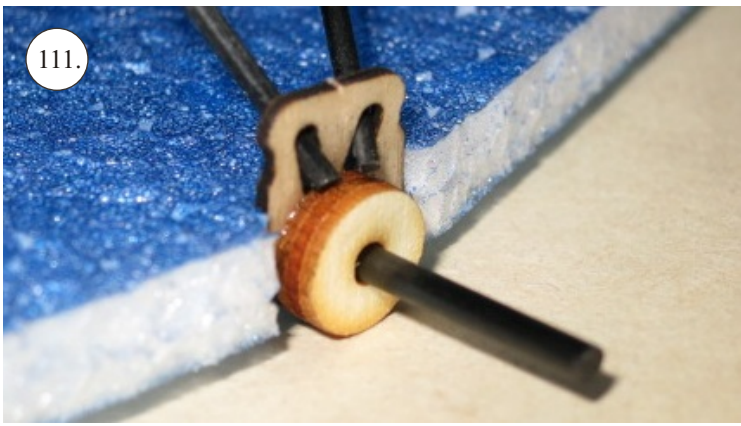

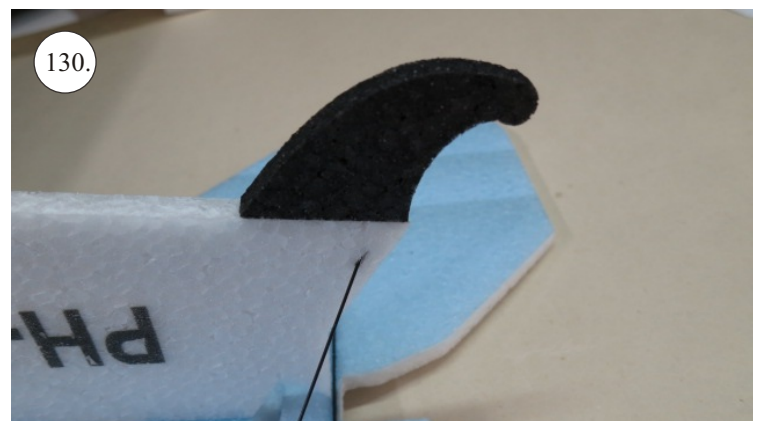
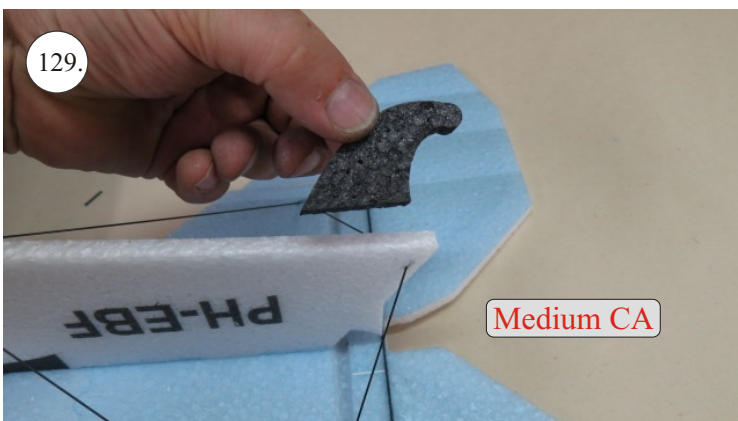
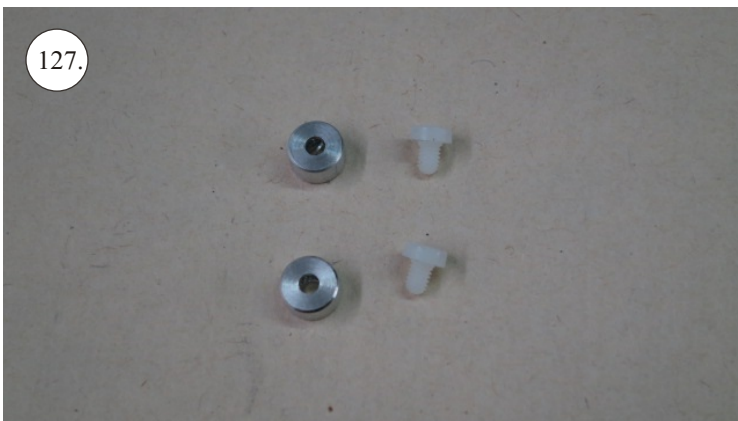
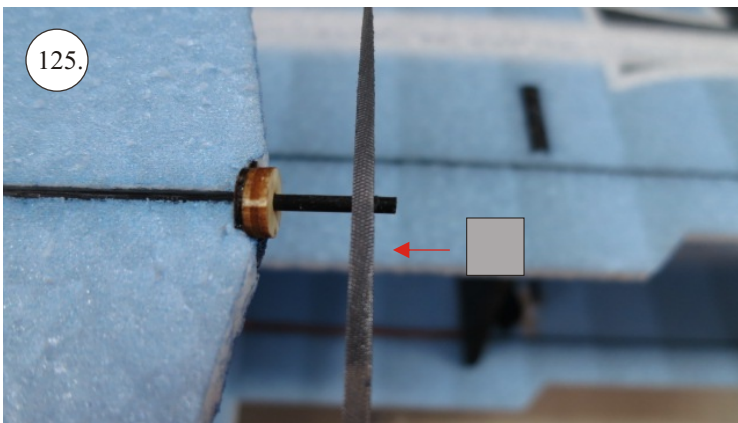
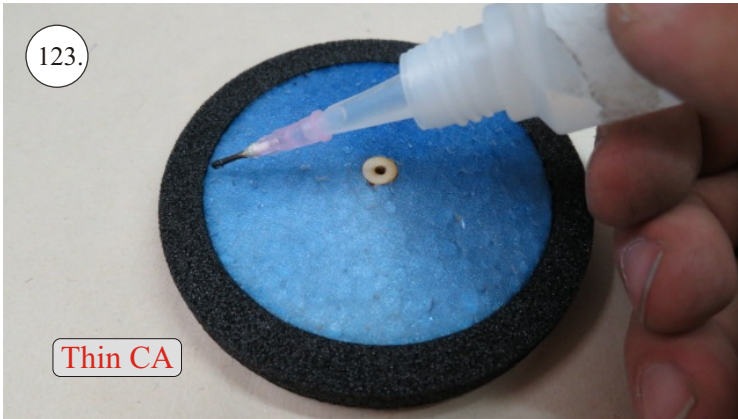
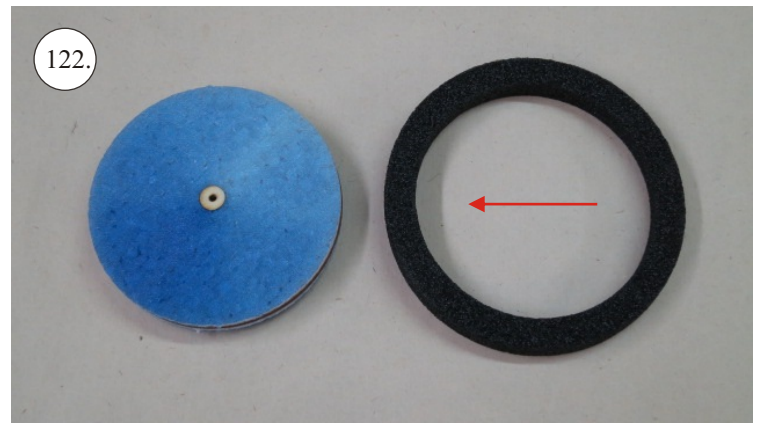
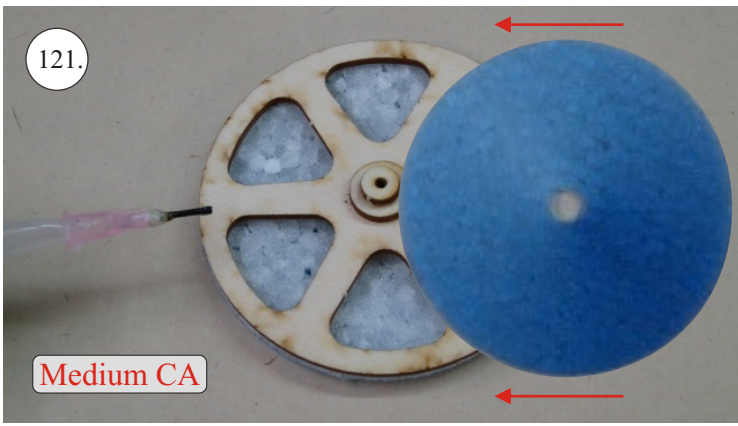

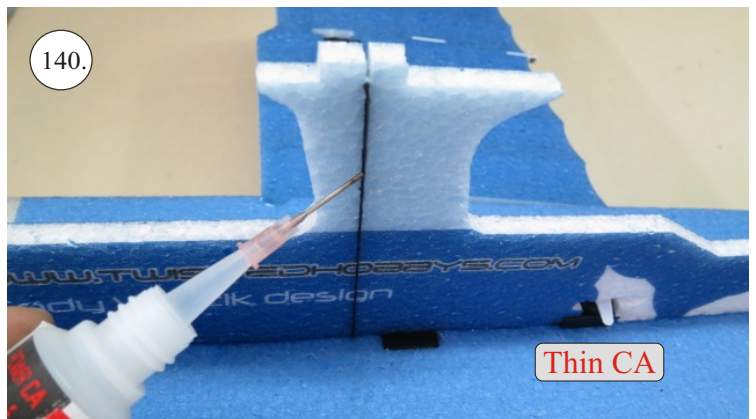
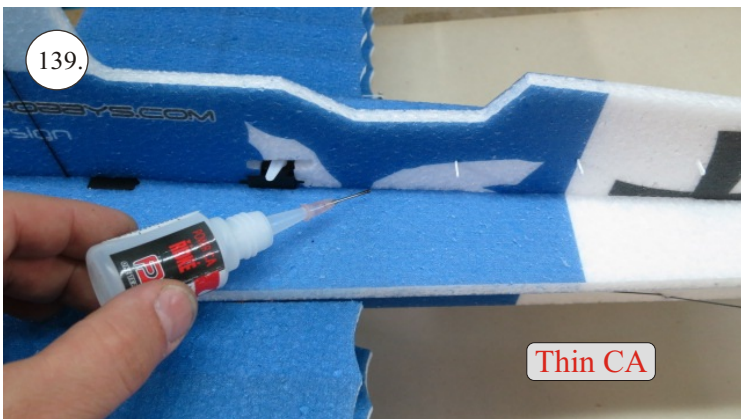
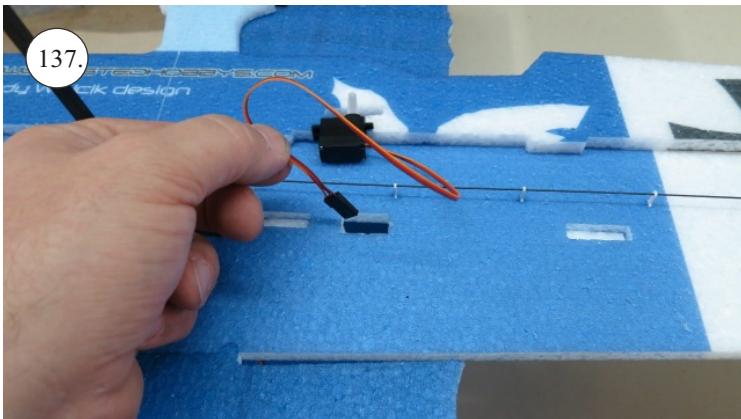
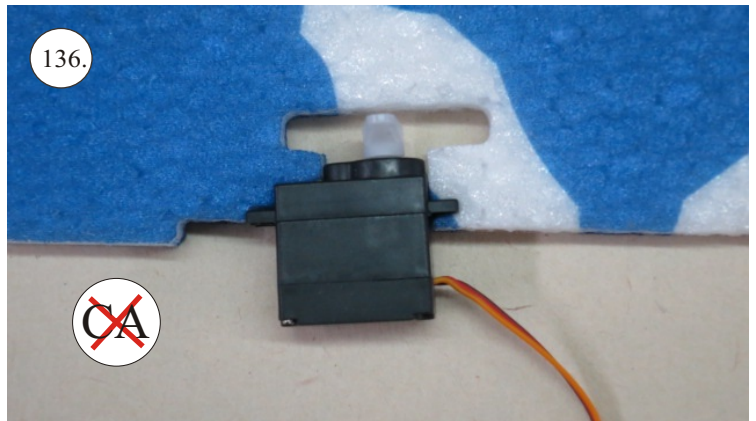
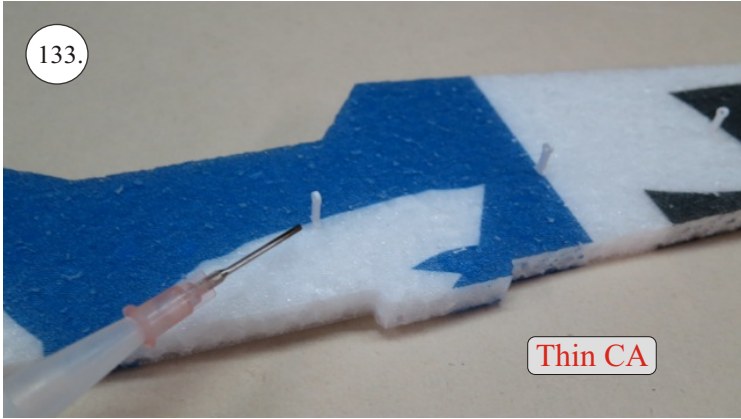
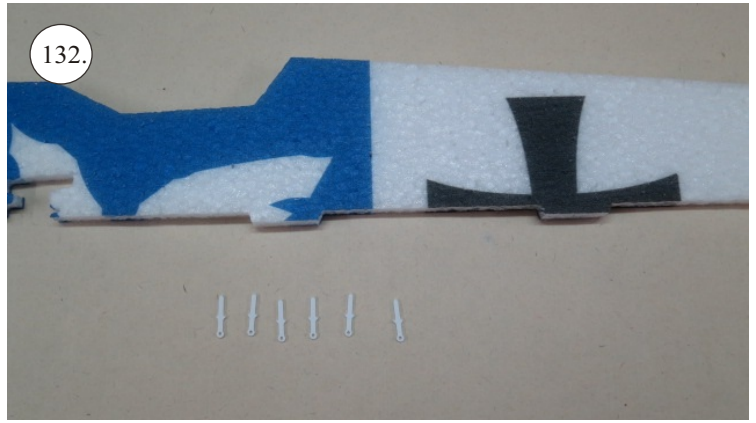
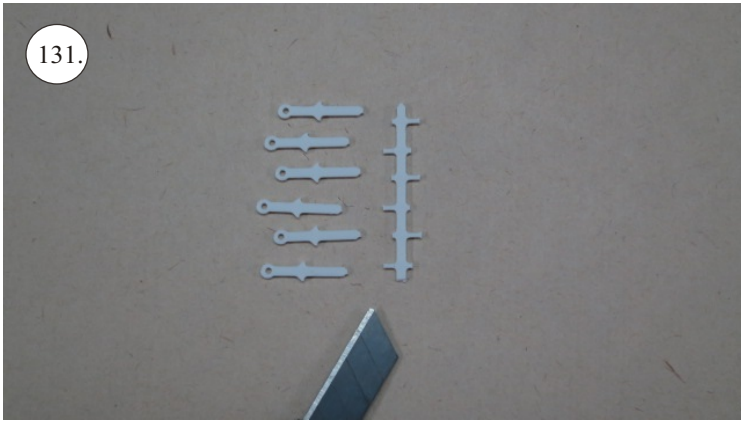

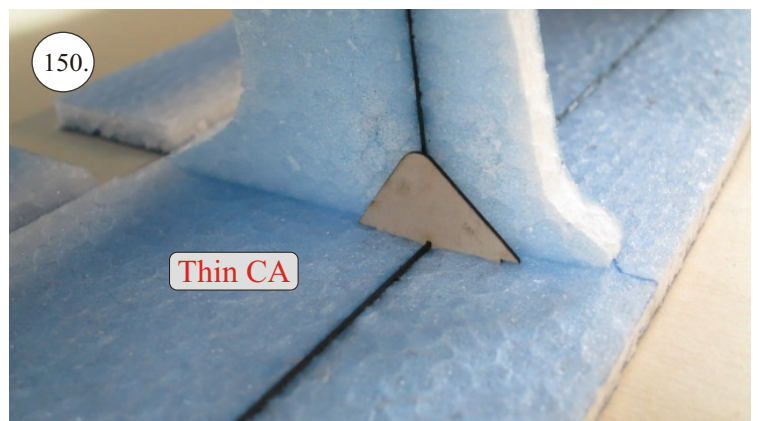
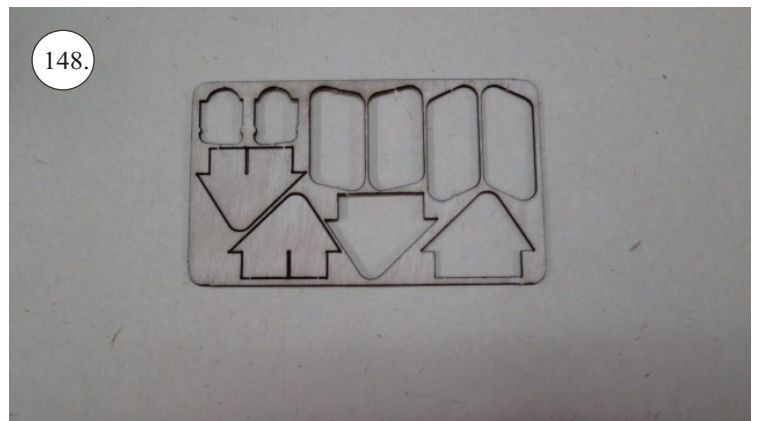
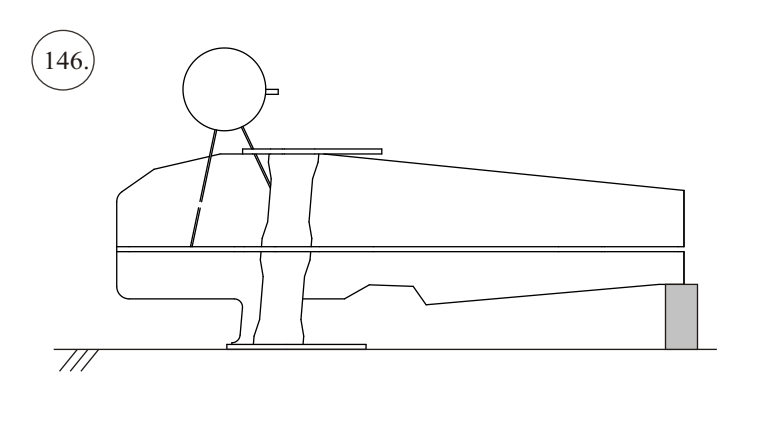
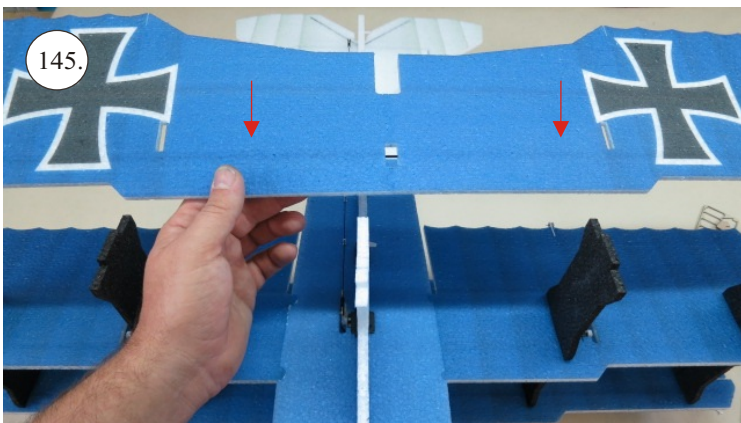
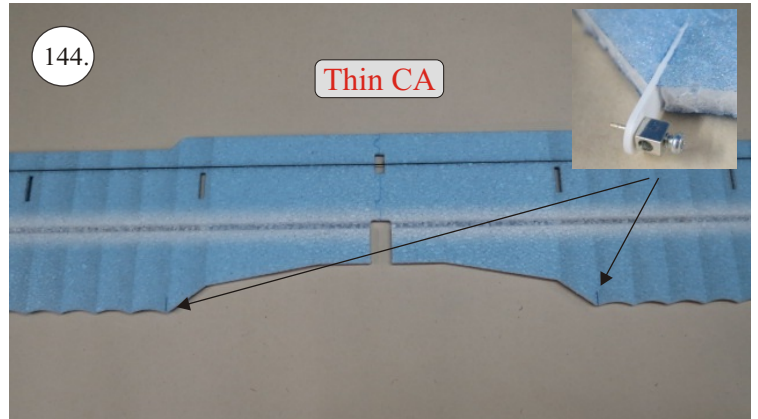
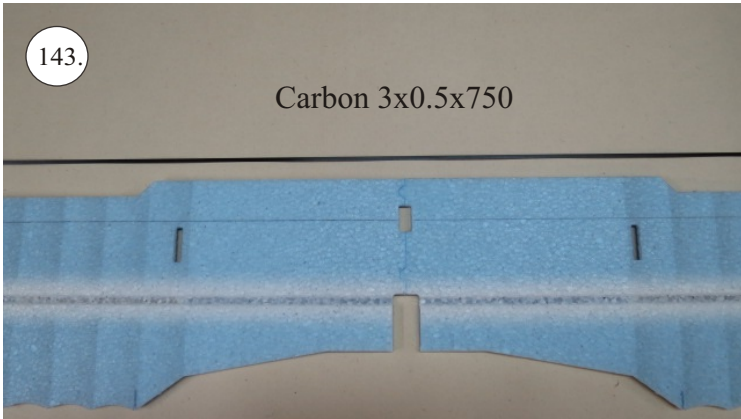
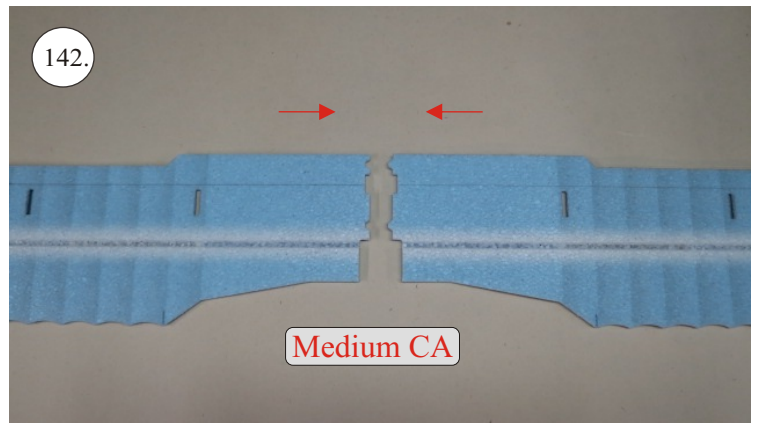
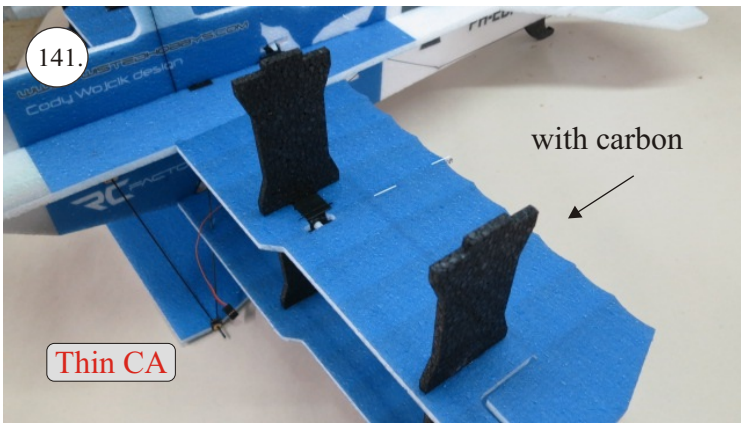

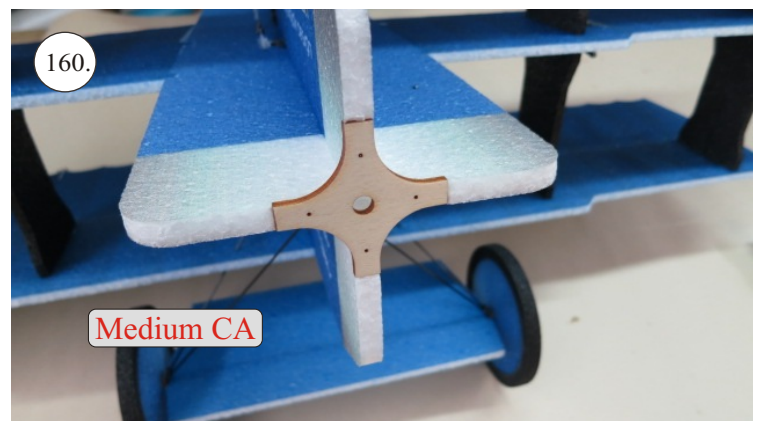
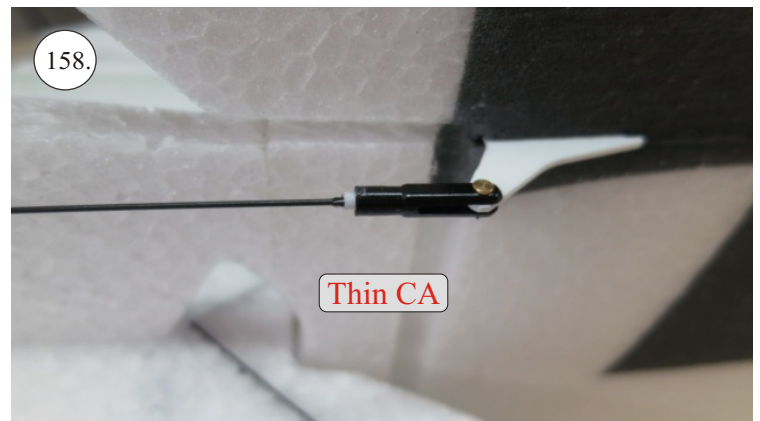
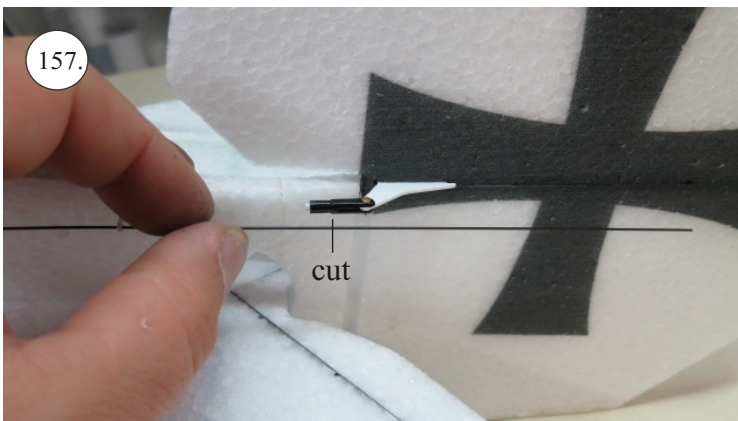
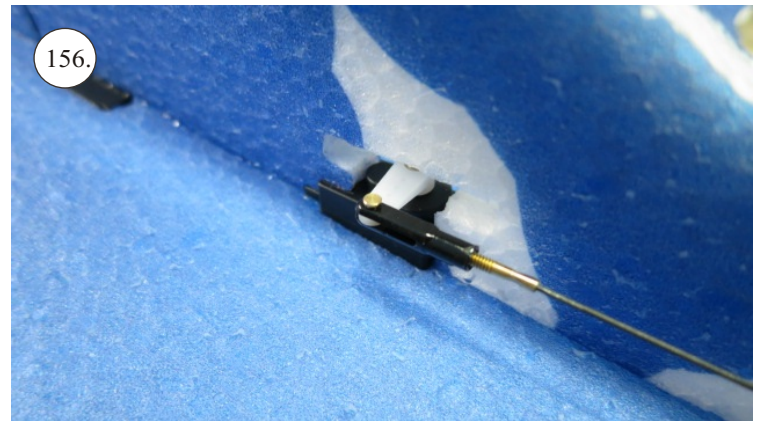
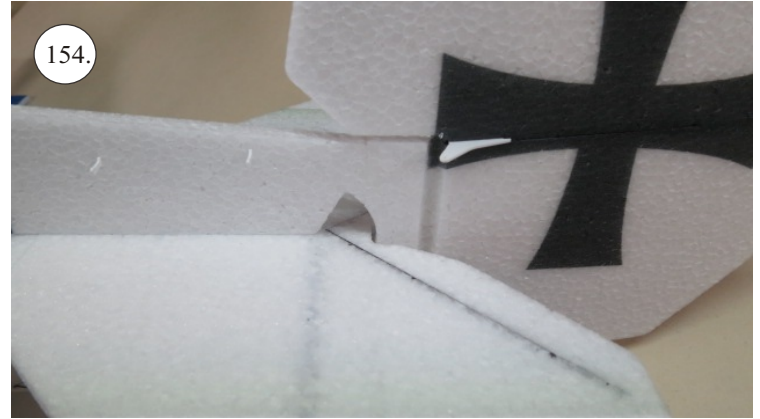
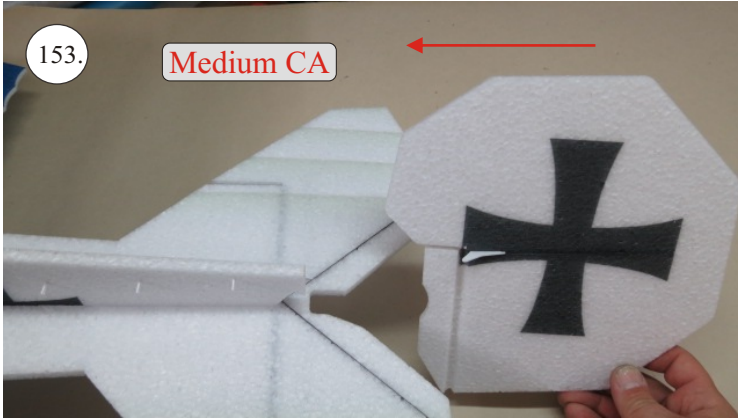
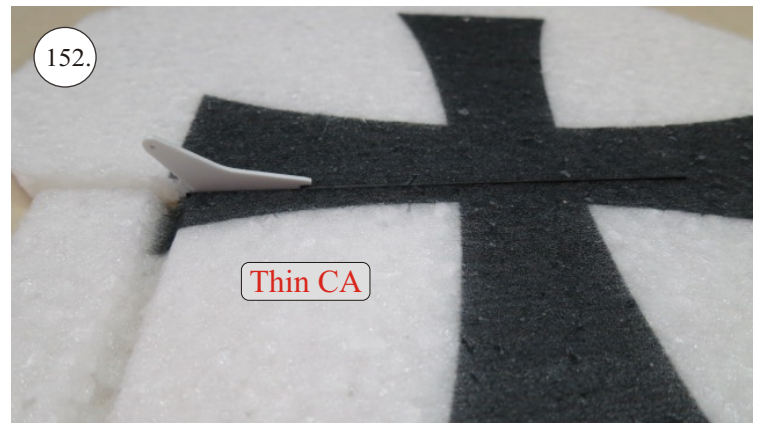
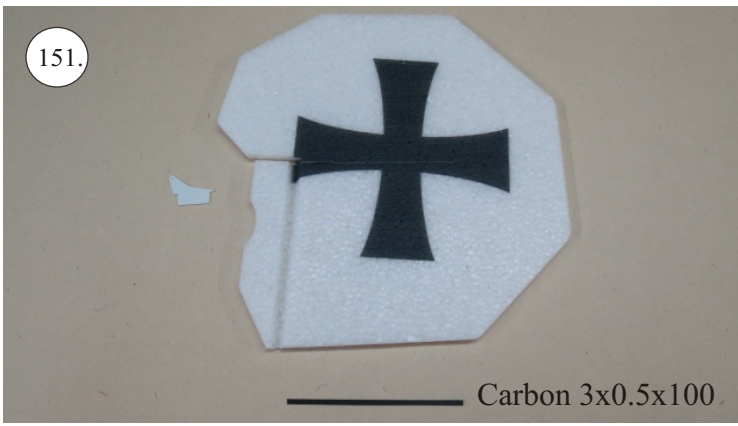

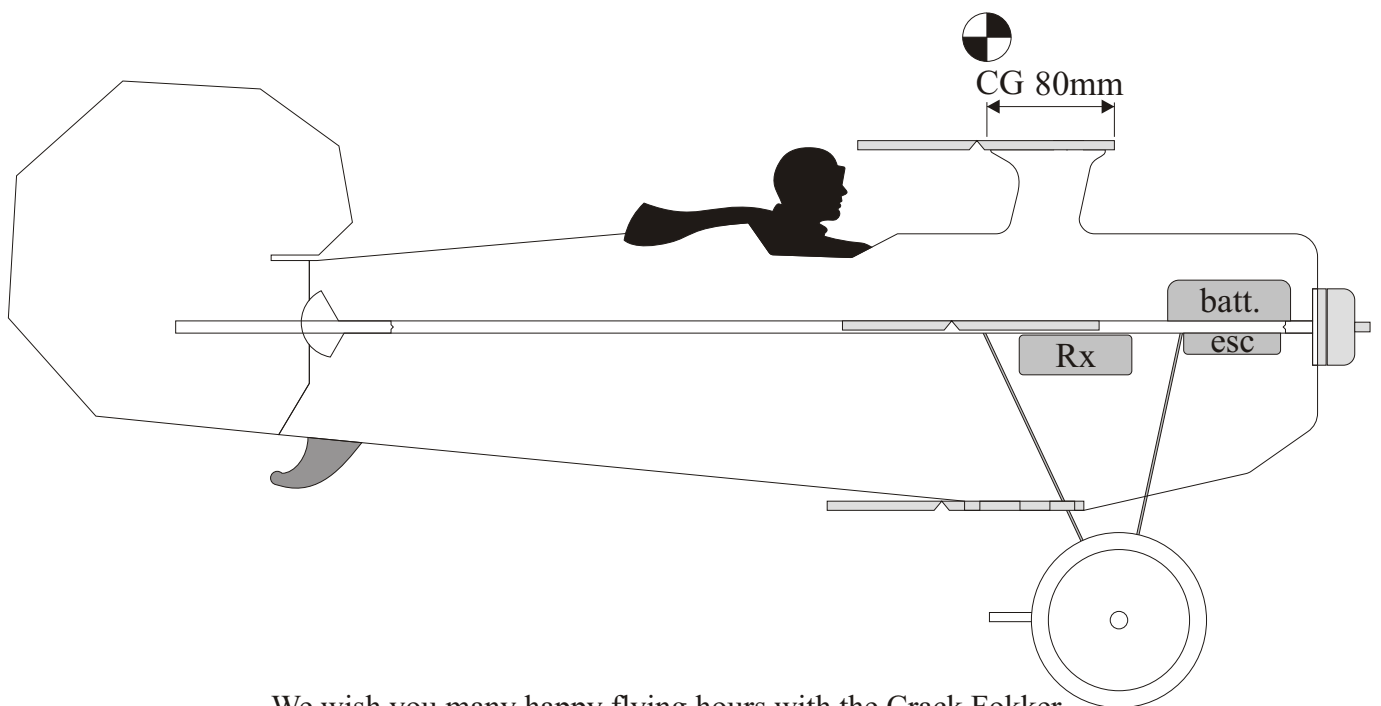
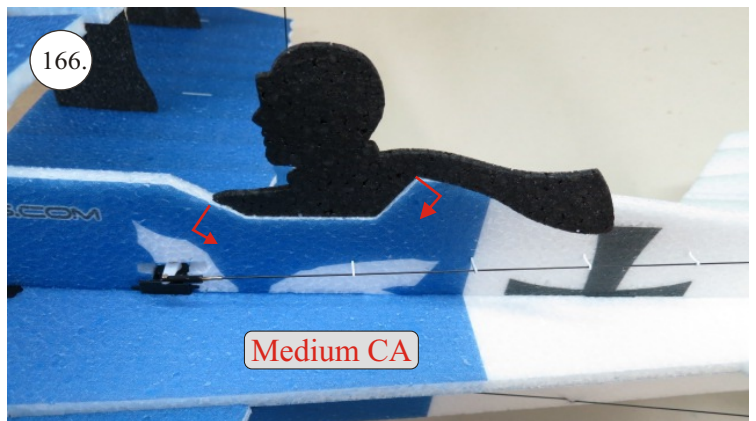
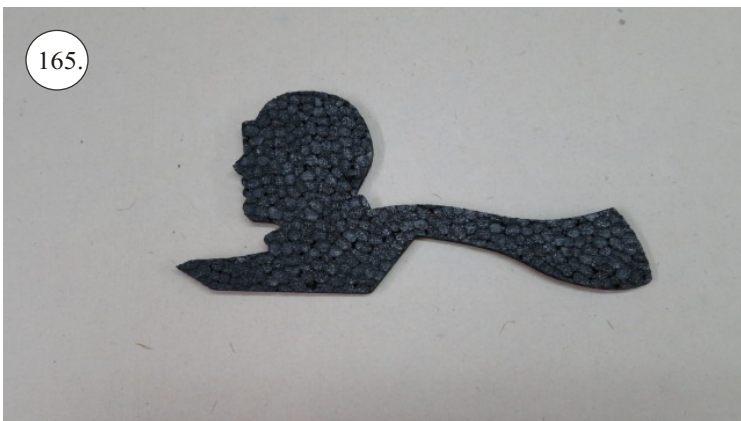
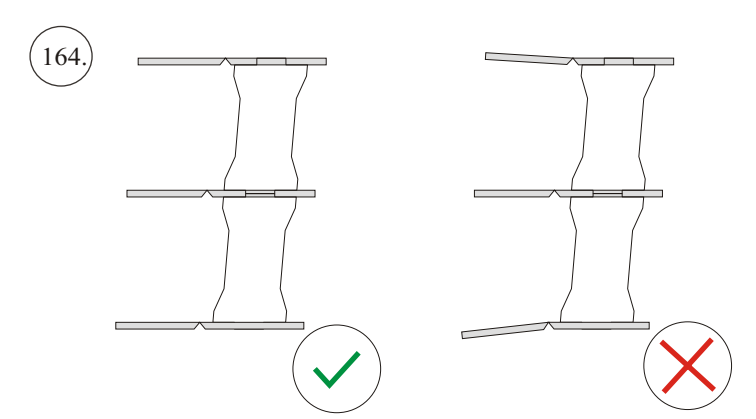
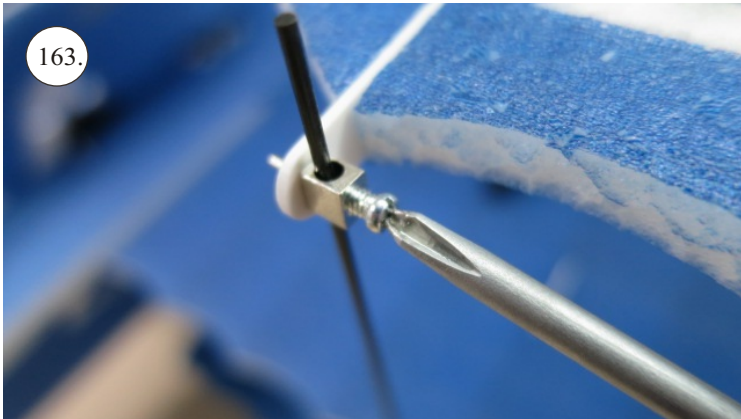
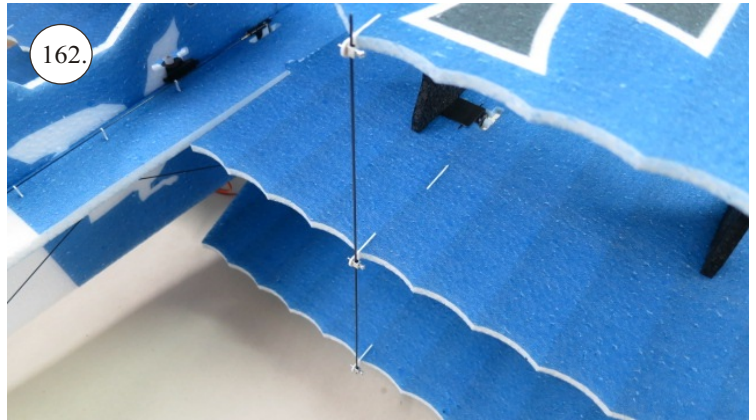
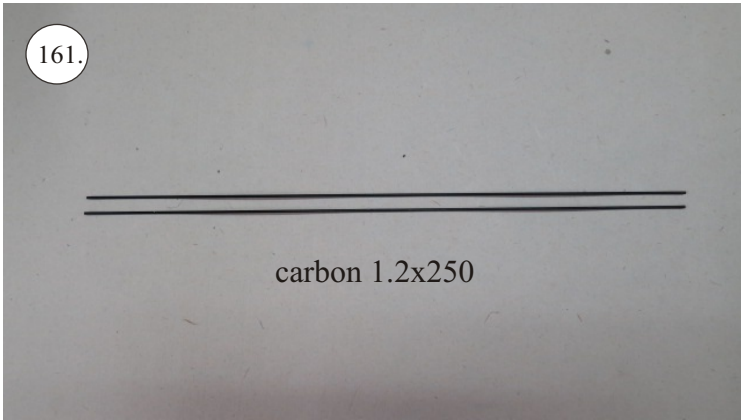

We wish you many happy flying hours with the Crack Fokker.

Your RC Factory team.